

# Readymades and displays

Furniture, displays  
and lighting



Aluvision 

# Discover our product range



## Bar-B 1350 v2

Type	Colour	Weight	Reference n°
Bar-B 1350 + RGB v2	W	74 kg	87 1001 W
	B	74 kg	87 1001 B
Bar-B 1350 v2	W	73 kg	87 1002 W
	B	73 kg	87 1002 B

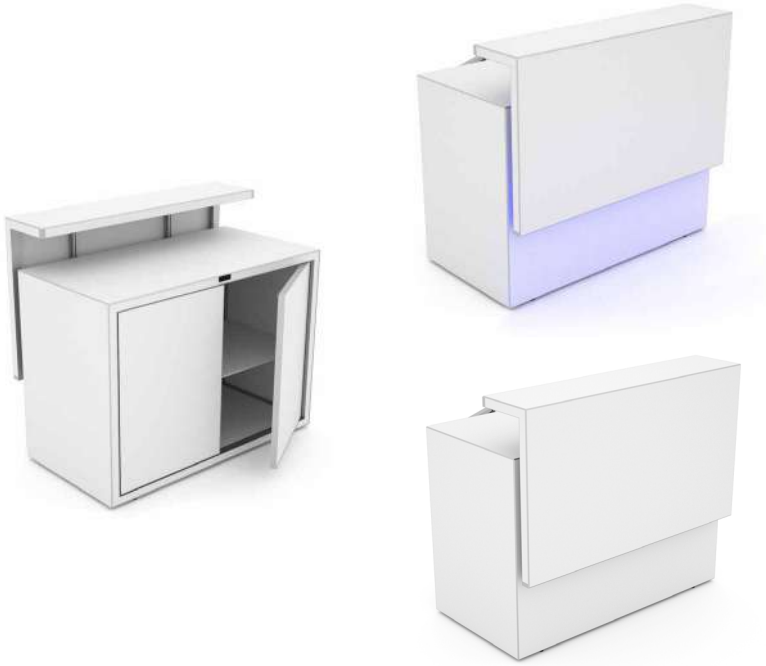

Aluvibond infills included.

### → Technical information

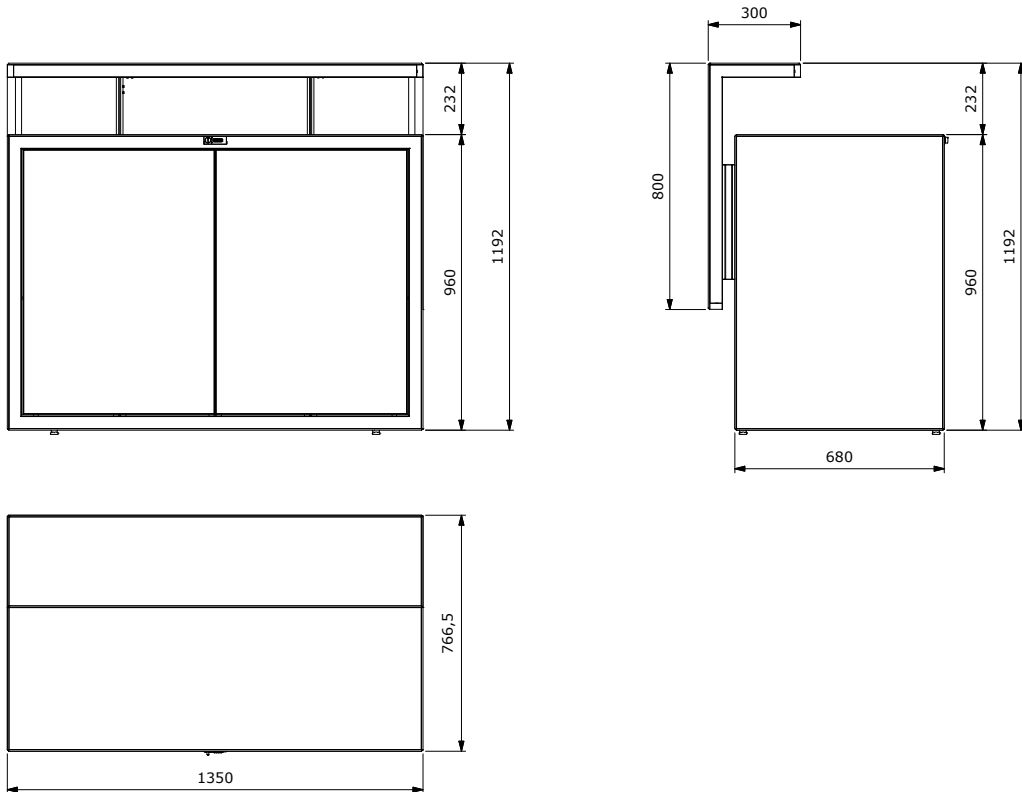

## Bar-B 1350 base v2

Type	Colour	Weight	Reference n°
Bar-B 1350 base v2	W	51,5 kg	87 1003 W
	B	51,5 kg	87 1003 B



Aluivbond infills included.

### → Technical information

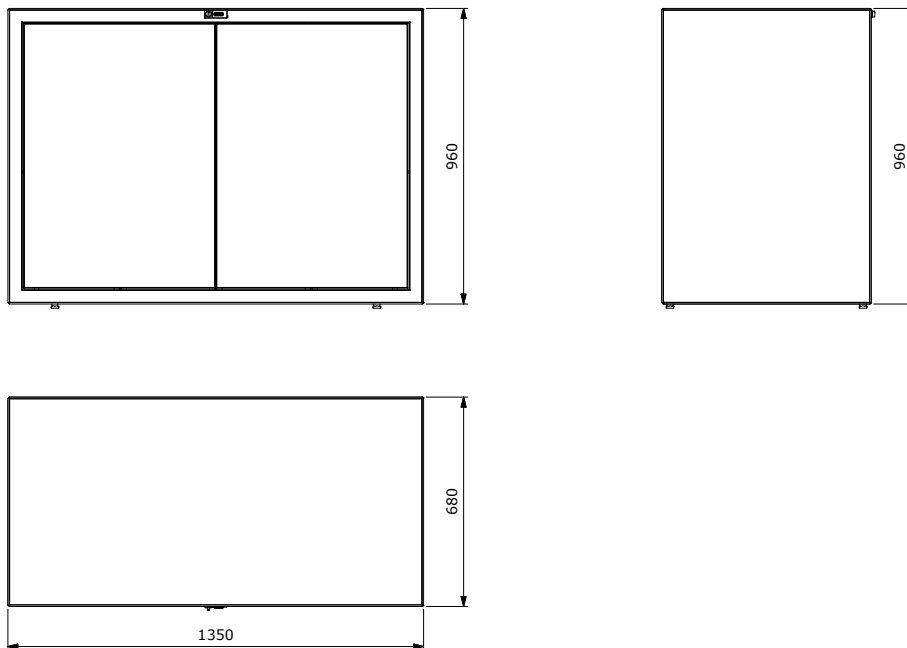

## Bar-B 1978 v2



Type	Colour	Weight	Reference n°
Bar-B 1978 + RGB v2	W	100 kg	87 1101 W
	B	100 kg	87 1101 B
Bar-B 1978 v2	W	100 kg	87 1102 W
	B	100 kg	87 1102 B

Aluvibond infills included.

## → Technical information

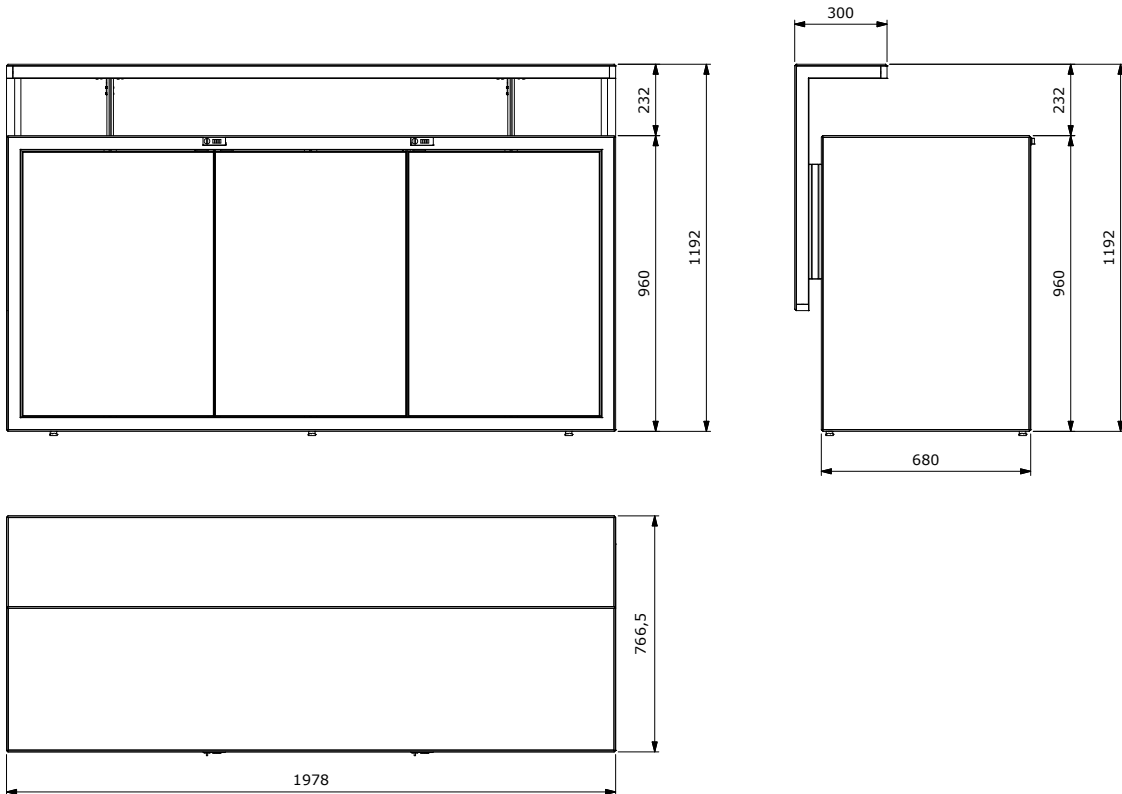

## Bar-B 1978 base v2

Type	Colour	Weight	Reference n°
Bar-B 1978 base v2	W	70 kg	87 1103 W
	B	70 kg	87 1103 B



Aluvibond infills included.

### → Technical information

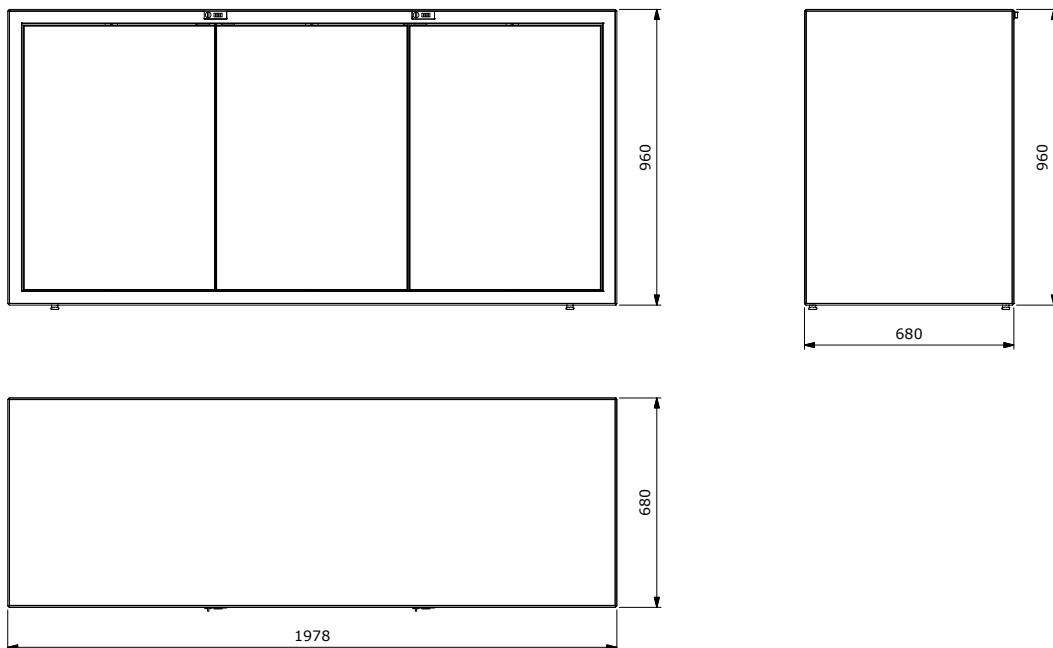

## Bar-B 90° v2

Type	Colour	Weight	Reference n°
Bar-B 90° + RGB v2	W	47 kg	87 1201 W
	B	47 kg	87 1201 B
Bar-B 90° v2	W	47 kg	87 1202 W
	B	47 kg	87 1202 B

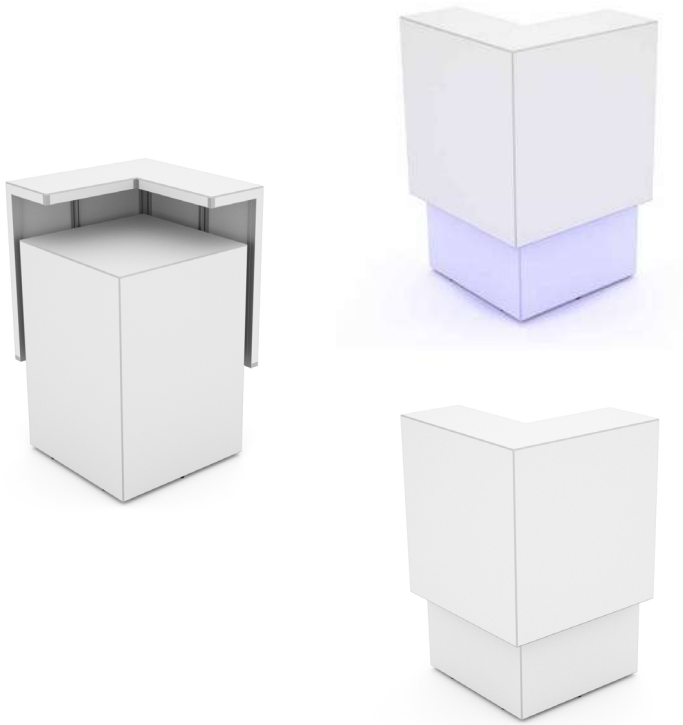

Aluvibond infills included.

## → Technical information

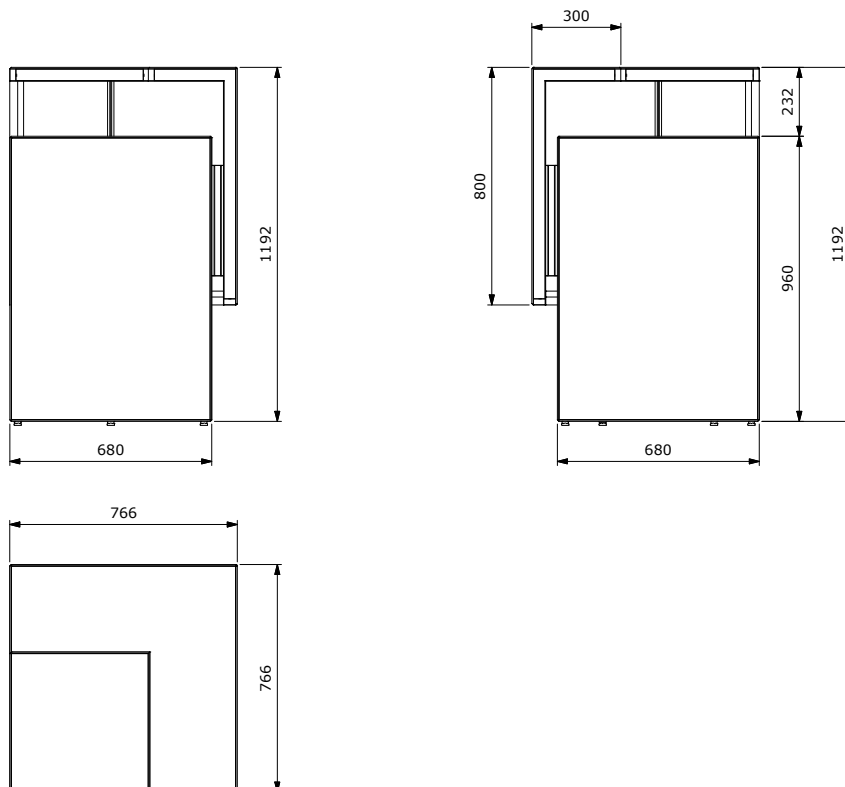

## Bar-B 90° base v2

Type	Colour	Weight	Reference n°
Bar-B 90° base v2	W	24 kg	87 1203 W
	B	24 kg	87 1203 B



Aluvibond infills included.

### → Technical information

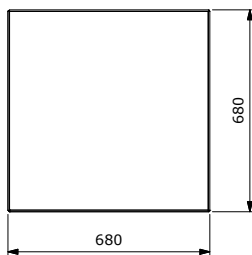
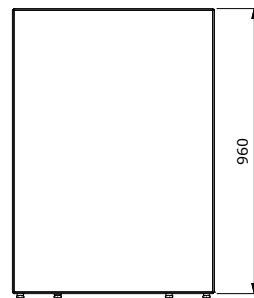
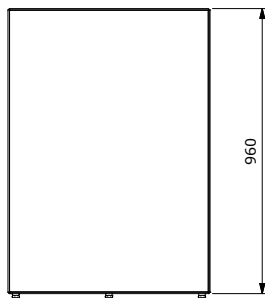



Join

Type	Colour	Weight	Reference n°
Join	W	37 kg	87 0401 W
	B	37 kg	87 0401 B
Join / SD	W	37 kg	87 0402 W
	B	37 kg	87 0402 B



Option pivot door  
Ref. 87 0401 W



Option sliding door  
Ref. 87 0402 W

Aluvibond infills included. Top & shelf not included. Delivered unassembled.

→ Technical information

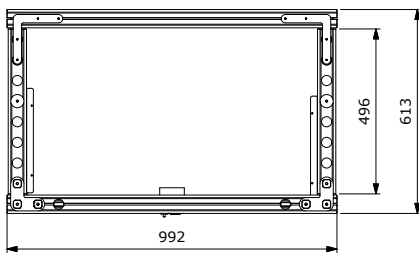
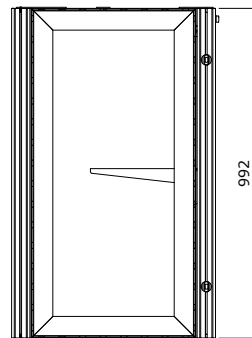
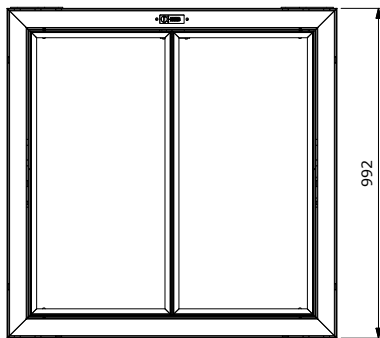

## LEDs Join

Type	Colour	Weight	Reference n°
LEDs Join	W	37 kg	87 0403 W
	B	37 kg	87 0403 B
LEDs Join / SD	W	37 kg	87 0404 W
	B	37 kg	87 0404 B



Option pivot door  
Ref. 87 0403 W



Option sliding door  
Ref. 87 0404 W

*Aluvibond infills & printed fabric included. Top & shelf not included. Delivered unassembled.*

## → Technical information

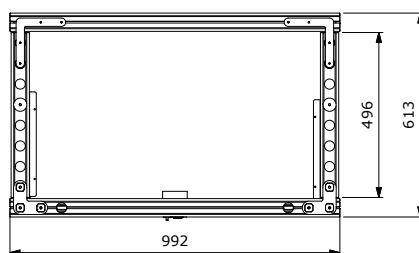
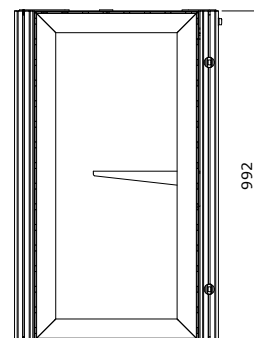
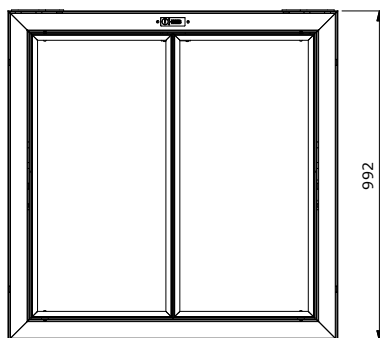

## Join UP



Type	Colour	Weight	Reference n°
Join UP	W	44 kg	87 0405 W
	B	44 kg	87 0405 B
Join UP / SD	W	44 kg	87 0406 W
	B	44 kg	87 0406 B

Aluvibond infills included. Top & shelf not included. Delivered unassembled.

## → Technical information

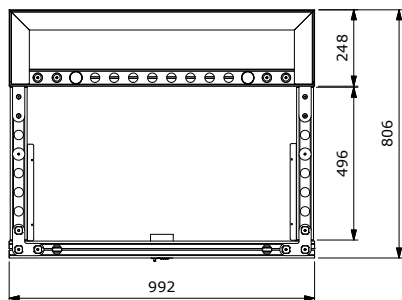
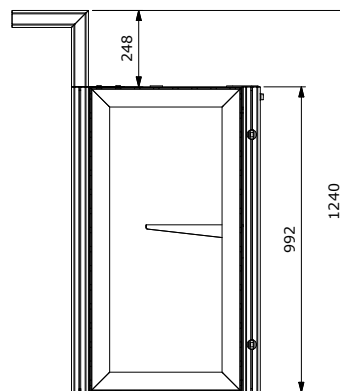
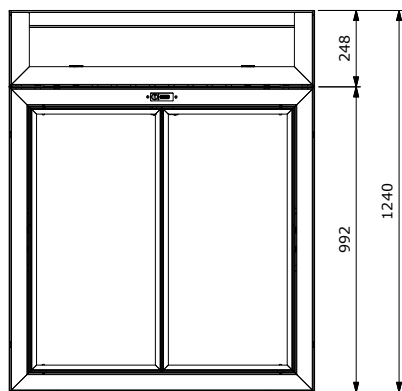

## LEDs Join UP

Type	Colour	Weight	Reference n°
LEDs Join UP	W	44 kg	87 0407 W
	B	44 kg	87 0407 B
LEDs Join UP / SD	W	44 kg	87 0408 W
	B	44 kg	87 0408 B



Aluvibond infills & printed fabric included. Top & shelf not included. Delivered unassembled.

## → Technical information

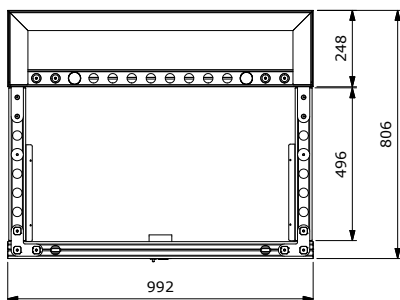
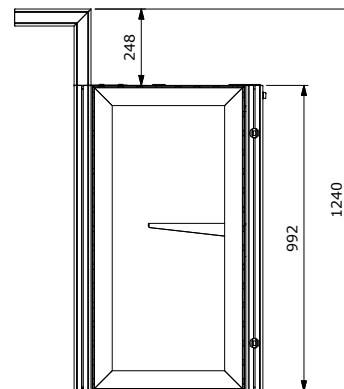
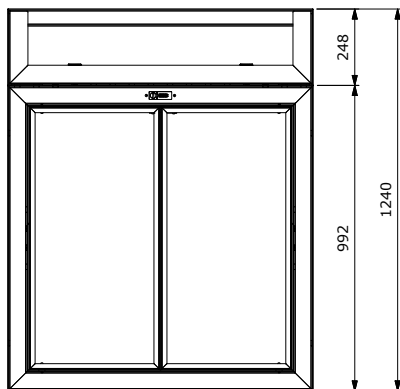

Meet

Type	Colour	Weight	Reference n°
Meet	W	40 kg	87 0501 W
	B	40 kg	87 0501 B
Meet / SD	W	40 kg	87 0502 W
	B	40 kg	87 0502 B



Option pivot door  
Ref. 87 0501 W



Option sliding door  
Ref. 87 0502 W

Aluvibond infills included. Top & shelf not included. Delivered unassembled.

→ Technical information

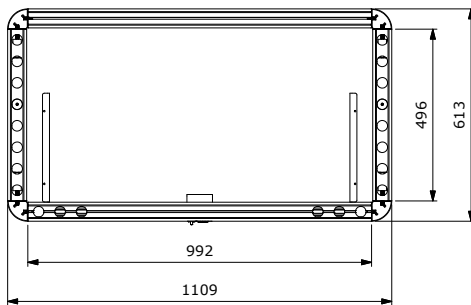
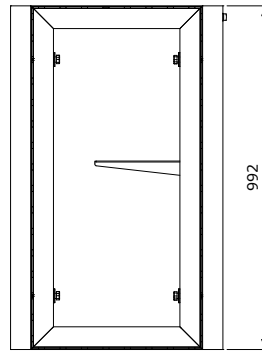
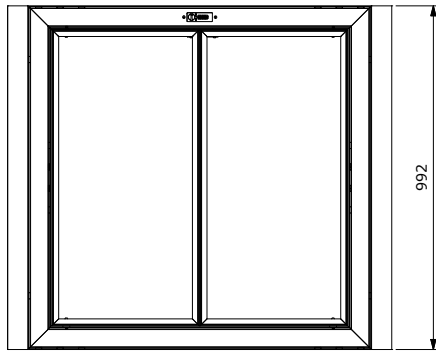

## LEDs Meet

Type	Colour	Weight	Reference n°
LEDs Meet	W	40 kg	87 0503 W
	B	40 kg	87 0503 B
LEDs Meet / SD	W	40 kg	87 0504 W
	B	40 kg	87 0504 B



Backlit



Option pivot door  
Ref. 87 0503 W



Option sliding door  
Ref. 87 0504 W

*Aluvibond infills & printed fabric included. Top & shelf not included. Delivered unassembled.*

## → Technical information

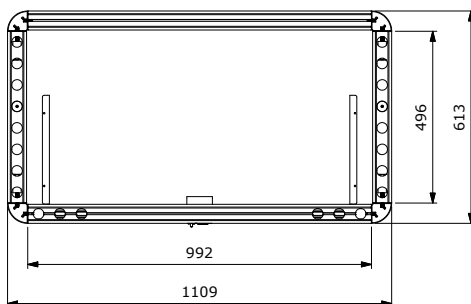
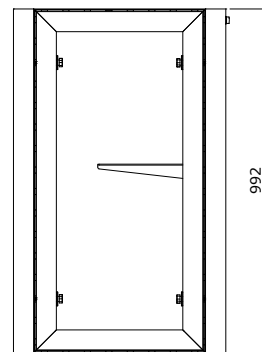
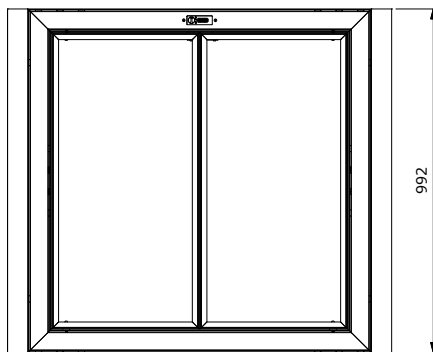

Meet 90° corner

Type	Colour	Weight	Reference n°
Meet 90° corner	W	67,93 kg	87 0505 W
	B	67,93 kg	87 0505 B
Meet 90° corner / SD	W	67,76 kg	87 0506 W
	B	67,76 kg	87 0506 B



Option pivot door  
Ref. 87 0505 W



Option sliding door  
Ref. 87 0506 W

Aluvibond infills included. Top & shelf not included. Delivered unassembled.

→ Technical information

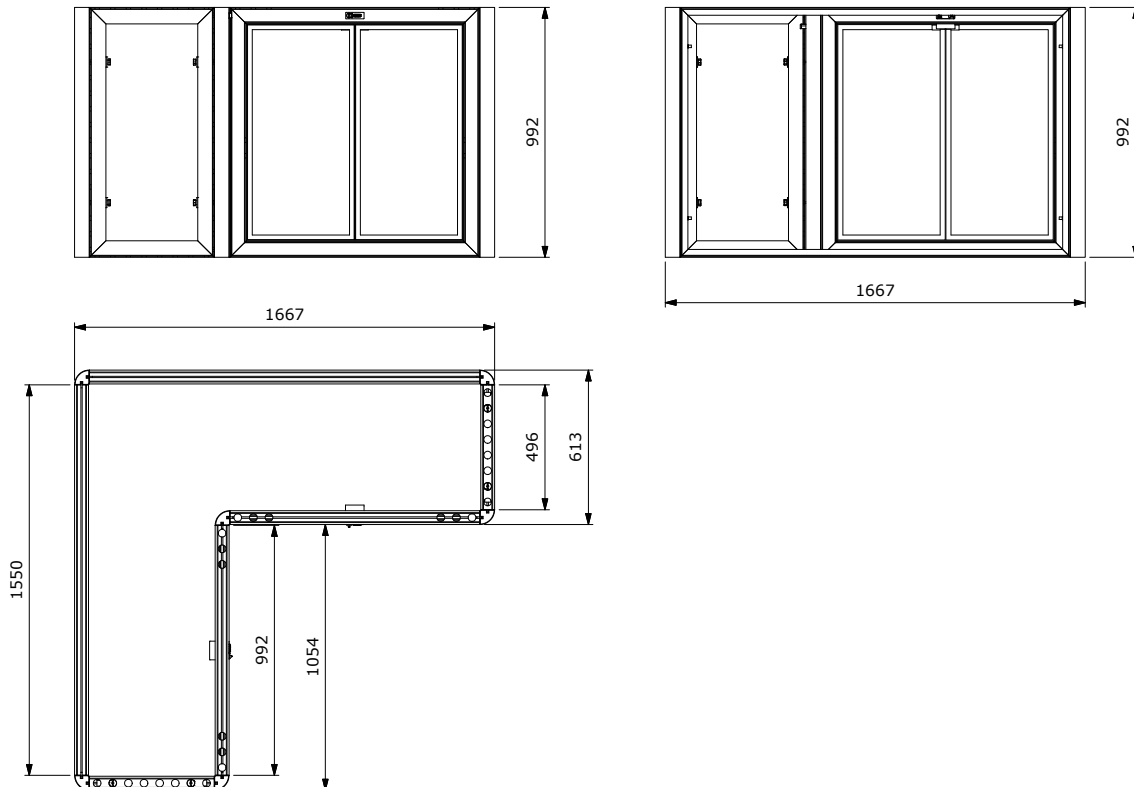

## LEDs Meet 90° corner

Type	Colour	Weight	Reference n°
LEDs Meet 90° corner	W	74,81 kg	87 0507 W
	B	74,81 kg	87 0507 B
LEDs Meet 90° corner / SD	W	74,64 kg	87 0508 W
	B	74,64 kg	87 0508 B



Option pivot door  
Ref. 87 0507 W



Backlit



Option sliding door  
Ref. 87 0508 W

*Aluivbond infills & printed fabric included. Top & shelf not included. Delivered unassembled.*

## → Technical information

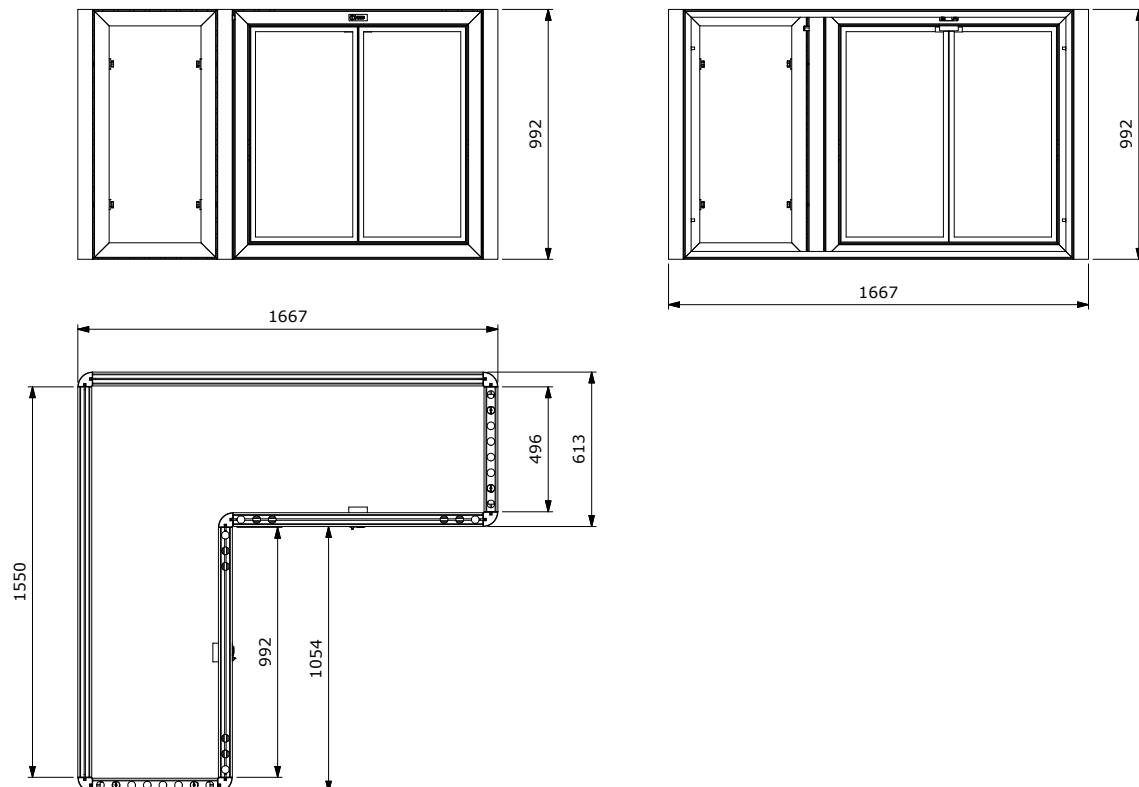



N-counter

Type	Colour	Weight	Reference n°
N-counter	W	65 kg	87 0601 W
	B	65 kg	87 0601 B
N-counter / SD	W	62 kg	87 0602 W
	B	62 kg	87 0602 B

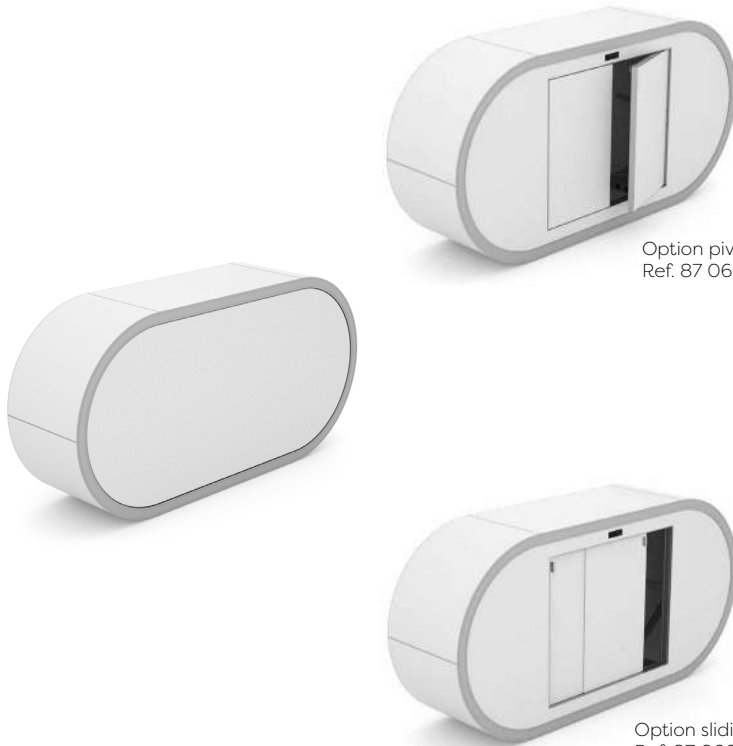

Aluvibond infills included. Top & shelf not included.

→ Technical information

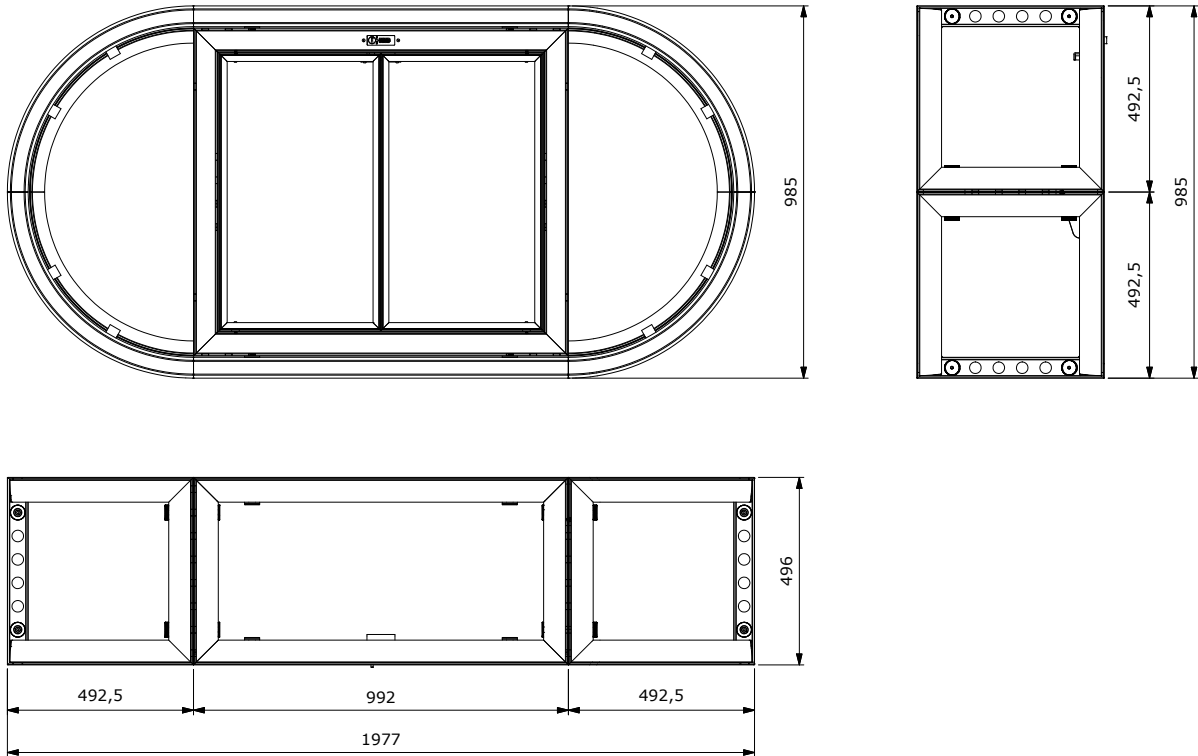

## LEDs N-counter

Type	Colour	Weight	Reference n°
LEDs N-counter	W	66 kg	87 0603 W
	B	66 kg	87 0603 B
LEDs N-counter / SD	W	63 kg	87 0604 W
	B	63 kg	87 0604 B

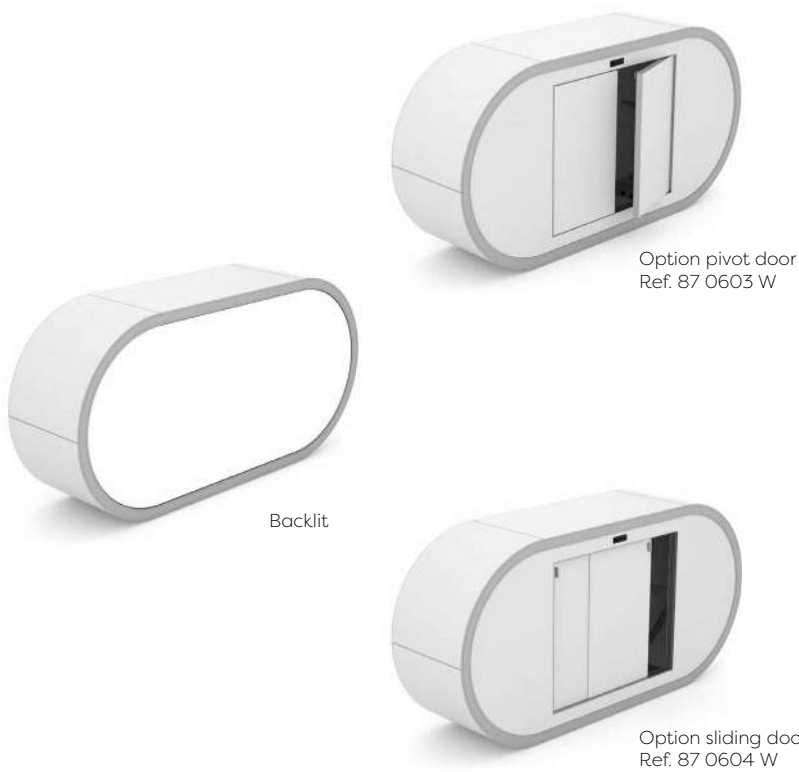

Aluvibond infills & printed fabric included. Top & shelf not included.

## → Technical information

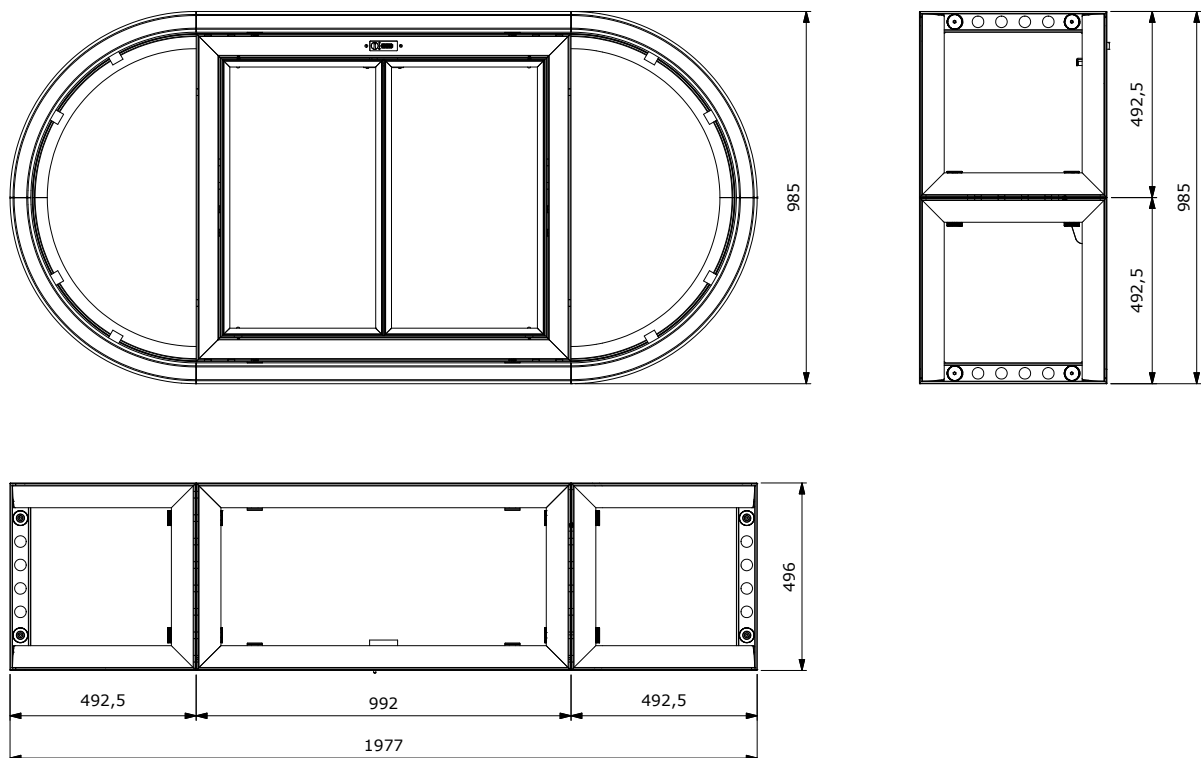

## Flex-it

Colour	Weight	Reference n°
W	24 kg	87 0701 W
B	24 kg	87 0701 B

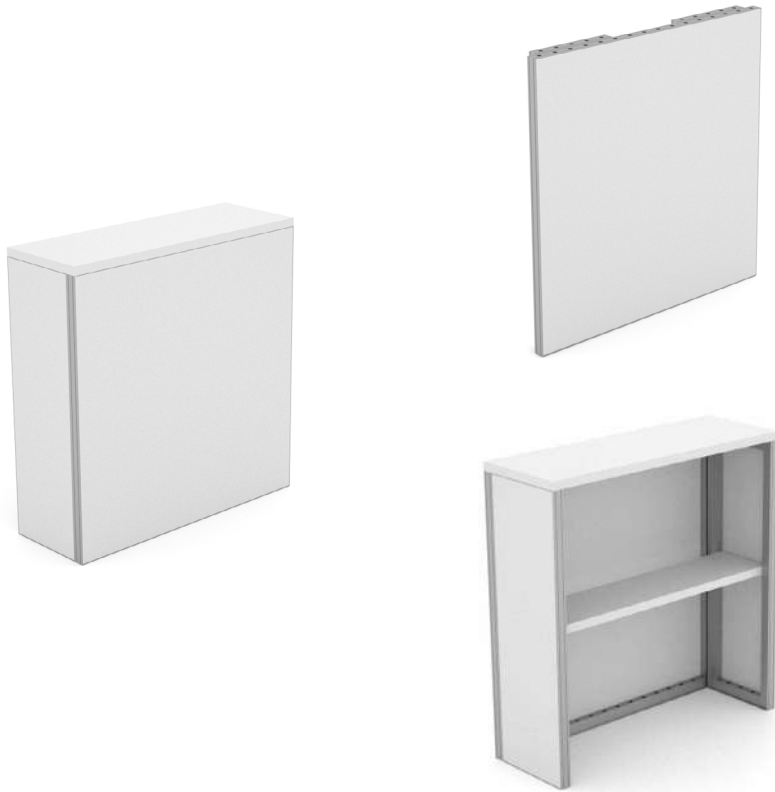

*Aluvibond infills ncluded. Top & shelf not included.*

## → Technical information

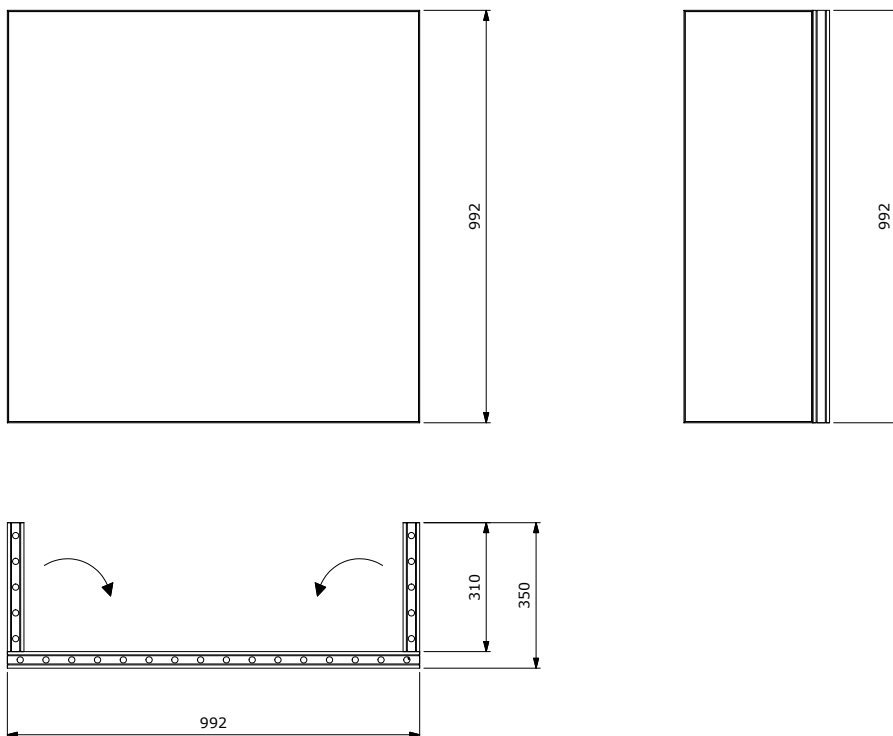

## Looping

Colour	Weight	Reference n°
W	70 kg	87 0801 W
B	70 kg	87 0801 B

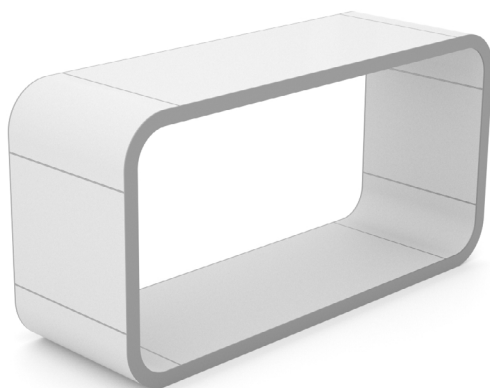

Aluvibond infills included. Delivered unassembled.

### → Technical information

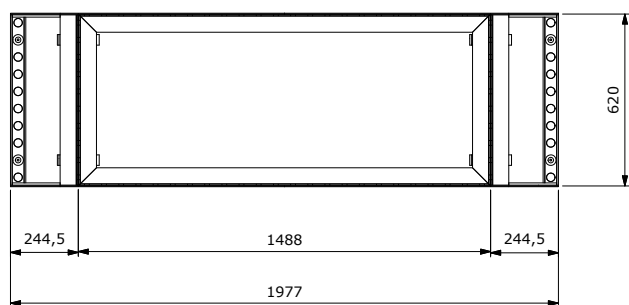
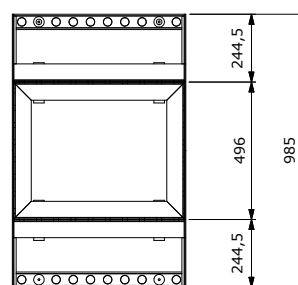
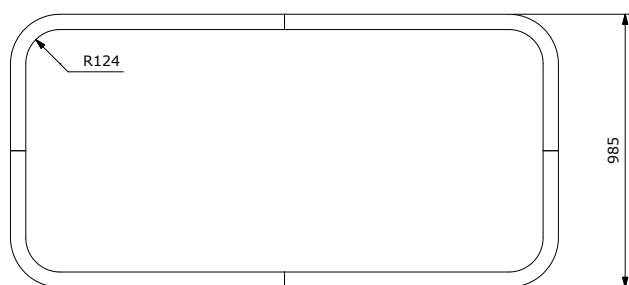

## B-box 310\*310\*744

Colour	Weight	Reference n°
W	12 kg	87 0901 W
B	12 kg	87 0901 B



Aluvibond infills included. Delivered unassembled.

### → Technical information

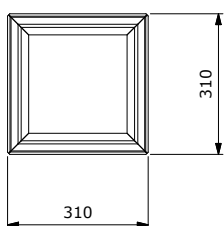
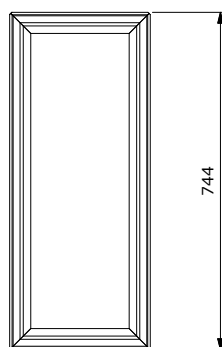
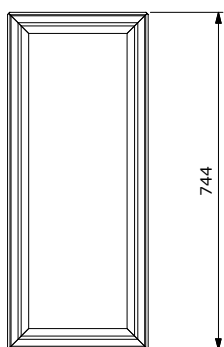

## B-box 496\*496\*992

Colour	Weight	Reference n°
W	19 kg	87 0902 W
B	19 kg	87 0902 B



*Aluivbond infills included. Delivered unassembled.*

### → Technical information

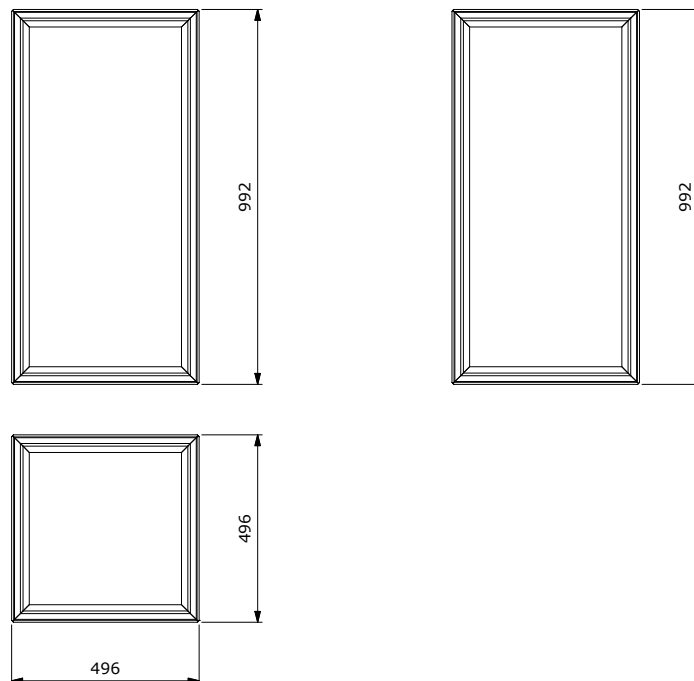

## B-Box Premium

Type	Colour	Weight	Reference n°
B-Box Premium	W	32 kg	87 0903 W
	B	32 kg	87 0903 B
B-Box Premium / SD	W	32 kg	87 0904 W
	B	32 kg	87 0904 B



Option pivot door  
Ref. 87 0903 W



Option sliding door  
Ref. 87 0904 W

Aluvibond infills included.

### → Technical information

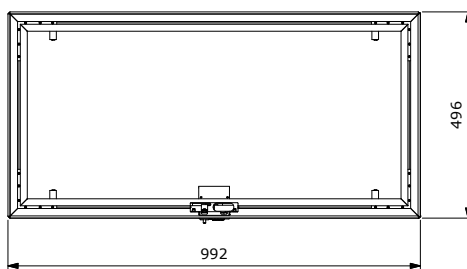
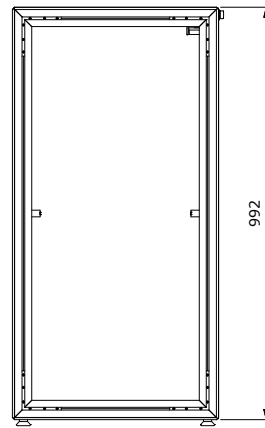
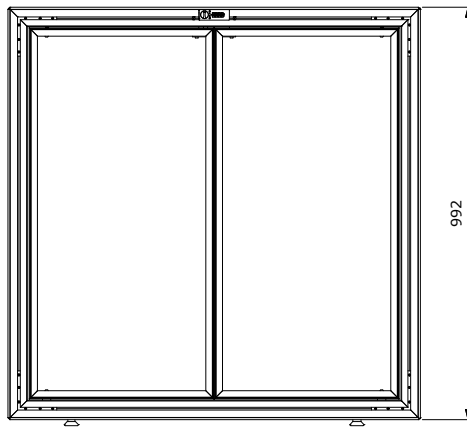

## Jack B

Colour	Weight	Reference n°
B	12 kg	86 0201 B



Top not included.

### → Technical information

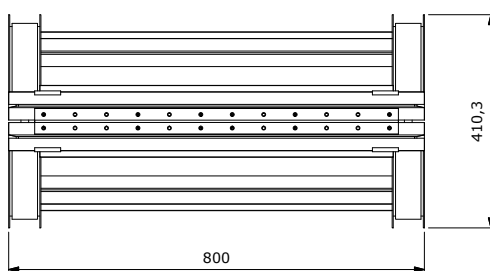
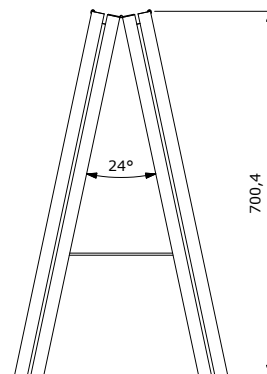
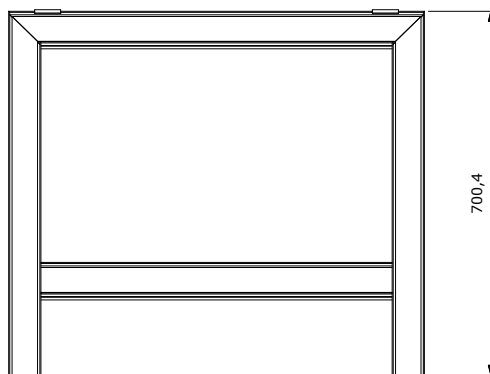



## Big Jack B

Colour	Weight	Reference n°
B	14 kg	86 0202 B



Top not included.

### → Technical information

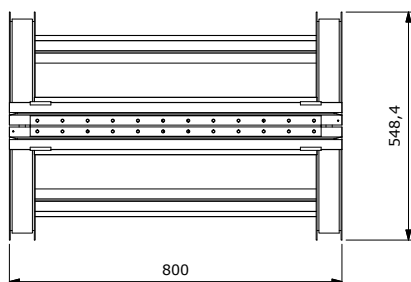
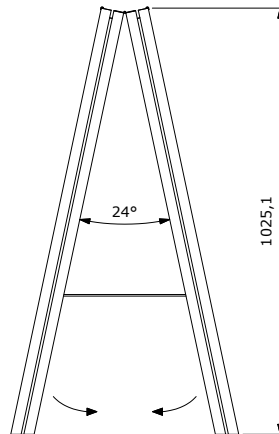
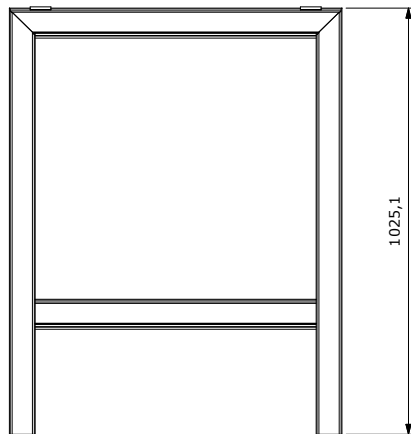

# Archie 1240 W

Colour	Weight	Reference n°
W	41 kg	86 0301 W

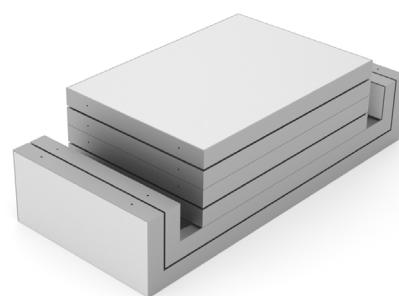

Aluvibond infills included.

## → Technical information

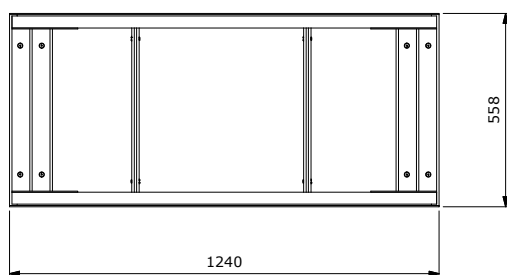
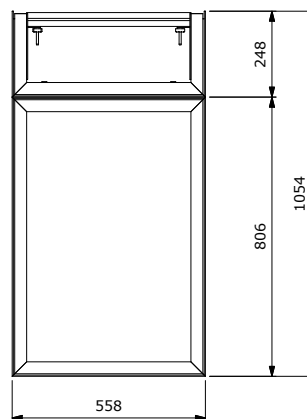
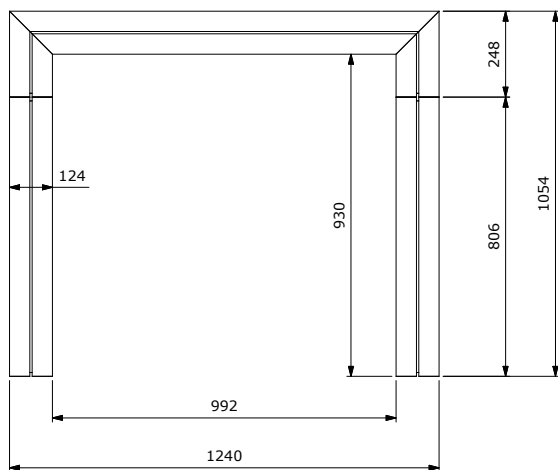

# Archie 1984 W

Colour	Weight	Reference n°
W	47 kg	86 0302 W

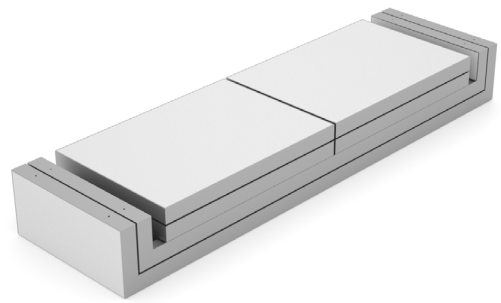

Aluvibond infills included.

## → Technical information

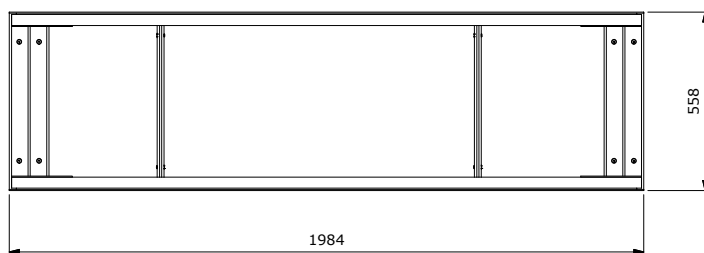
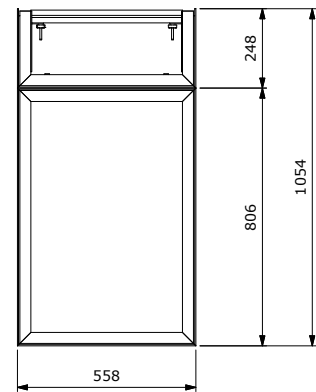
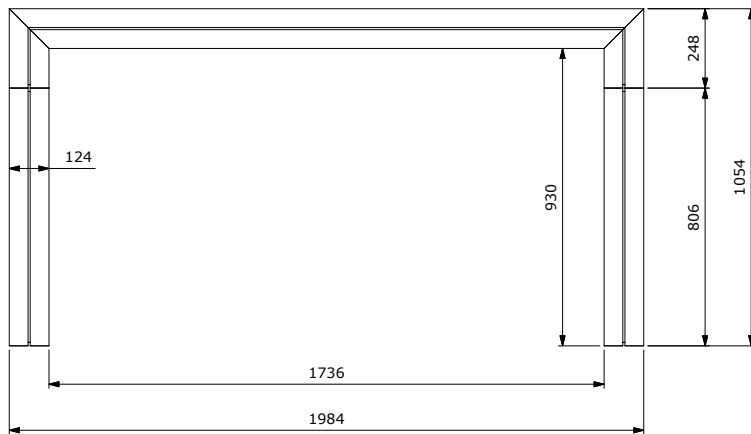

## Teck 2000 A

Colour	Weight	Reference n°
A	22 kg	86 0401 A



Top not included. Delivered unassembled.

### → Technical information

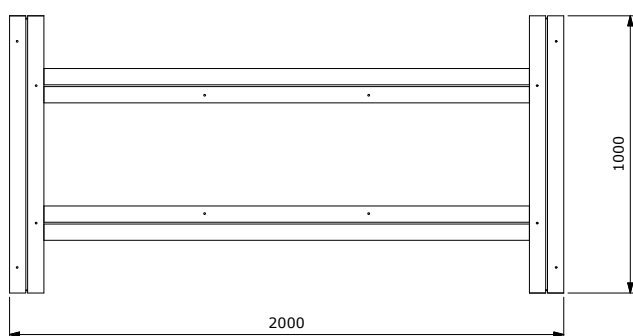

## High-Teck 800 A

Colour	Weight	Reference n°
A	17 kg	86 0402 A



Top not included. Delivered unassembled.

### → Technical information

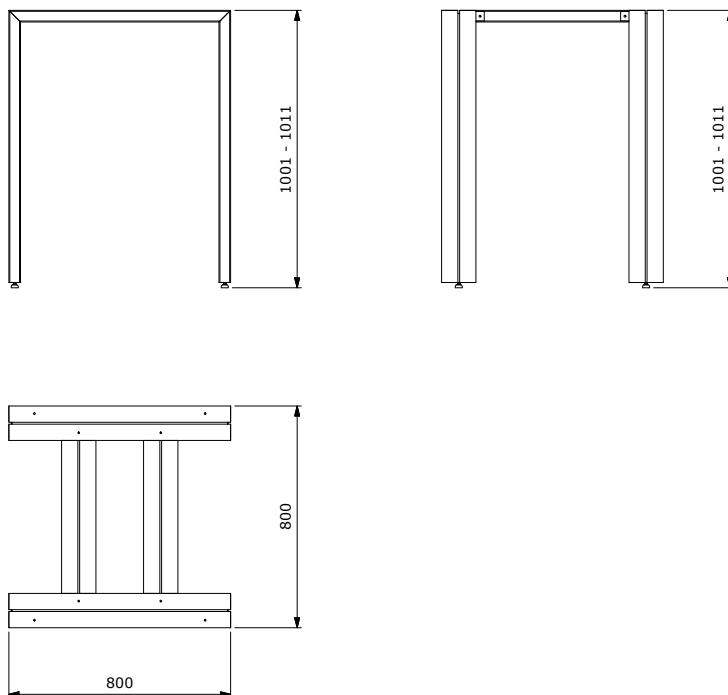

## High-Teck 2000 A

Colour	Weight	Reference n°
A	23 kg	86 0403 A



Top not included. Delivered unassembled.

### → Technical information

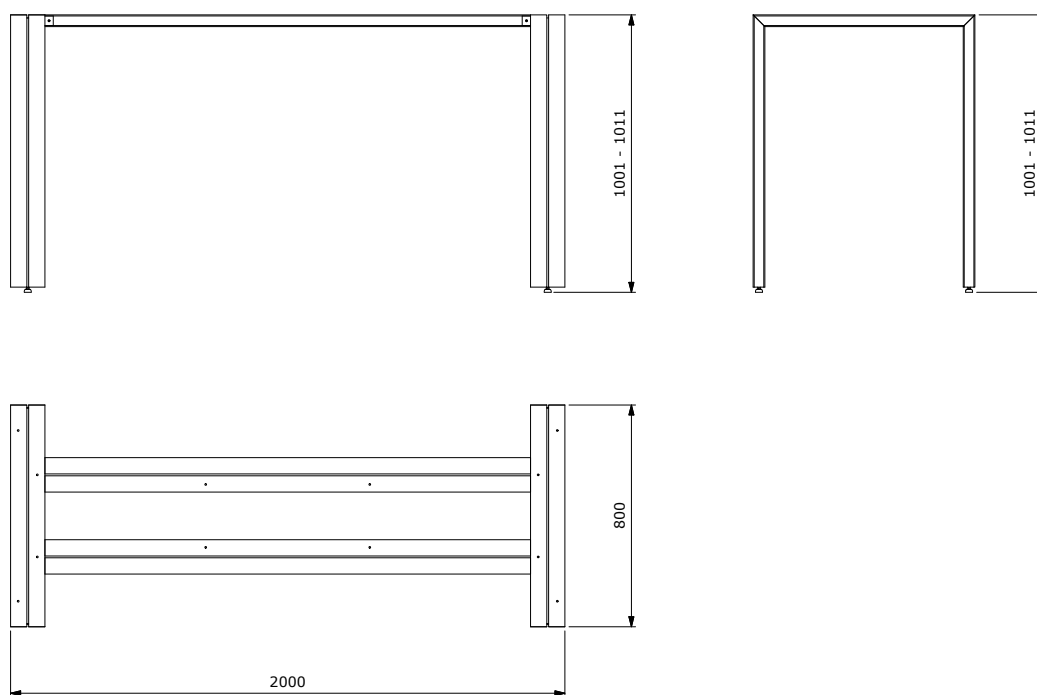

# Benta

Colour	Weight	Reference n°
W	54 kg	86 0101 W
B	54 kg	86 0101 B



Aluivbond Infills included. Finish W: white infills & black profiles. Finish B: black infills & anodised profiles.

## → Technical information

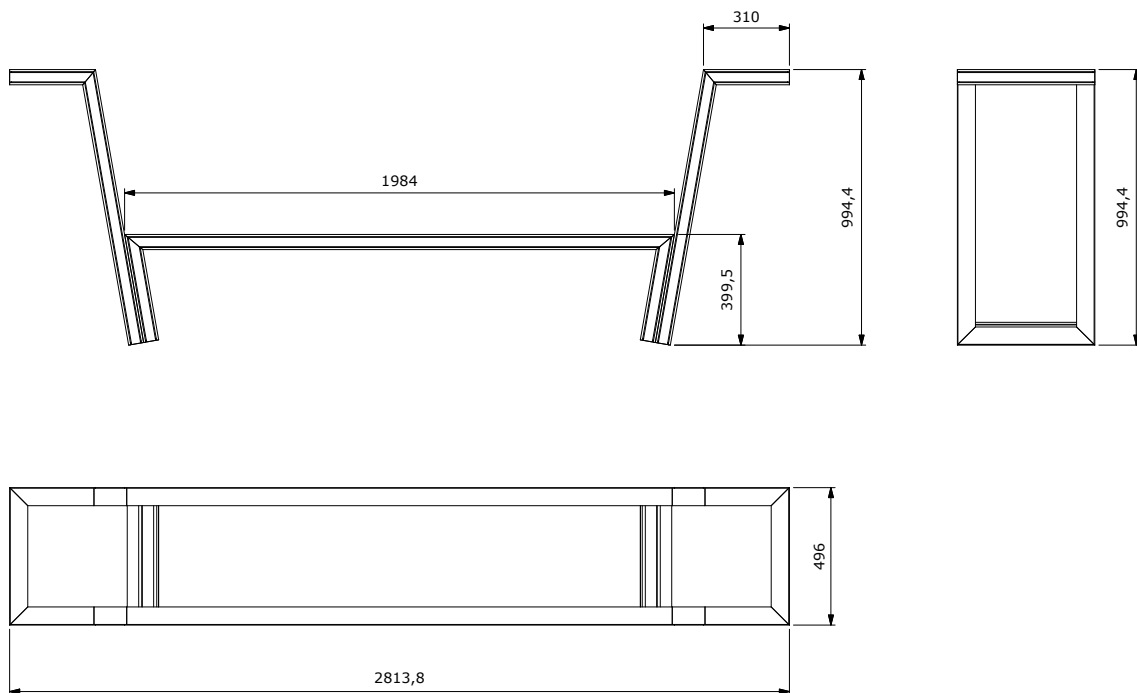

## Trans-it A

Colour	Weight	Reference n°
A	10,39 kg	88 0301



Grey aluvibond infills included. Including two bases and four acrylic folderholders (A4).

### → Technical information

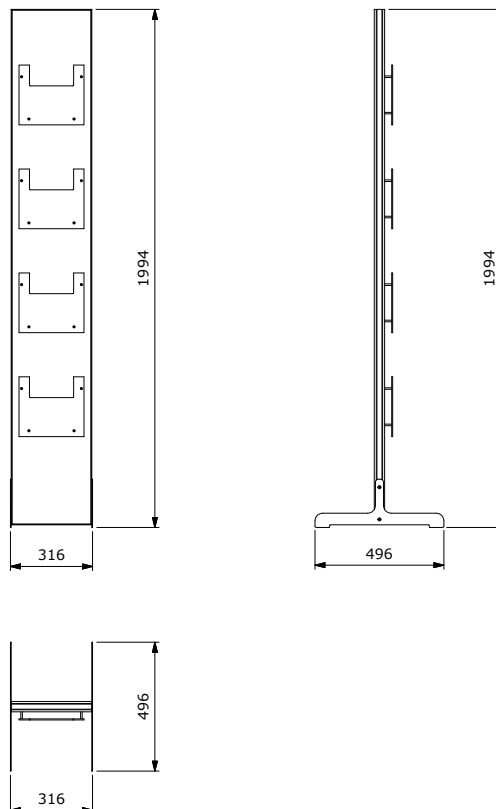



Colour	Weight	Reference n°
W	12,08 kg	88 0601 W
B	12,08 kg	88 0601 B



Suited for:  
iPad 2,3,4  
iPad Air, 2, 5, 6  
iPad Pro 9.7"

Aluvibond infills included. Use free standing or fixed on the floor.

## → Technical information

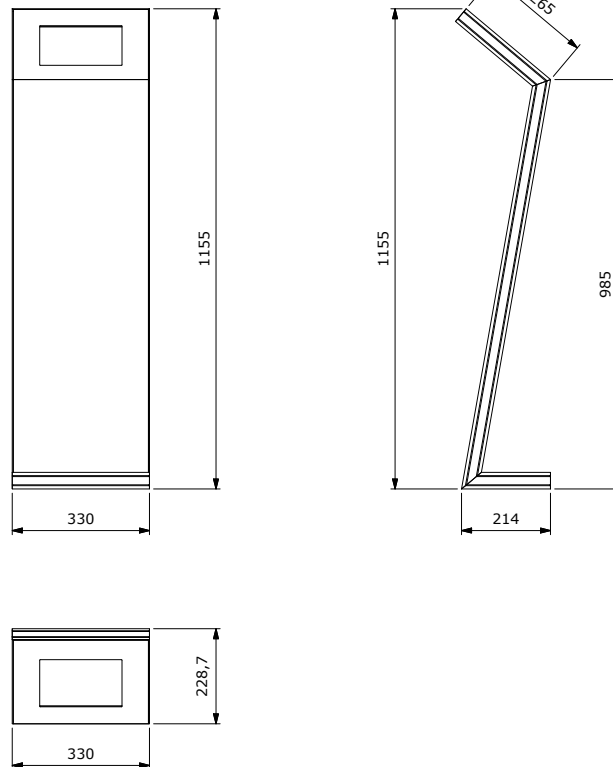

## iCon XL

Colour	Weight	Reference n°
W	50 kg	88 0602 W
B	50 kg	88 0602 B



Aluivbond infills included. Suited for TV max. 695 x 545 x 110mm.

### → Technical information

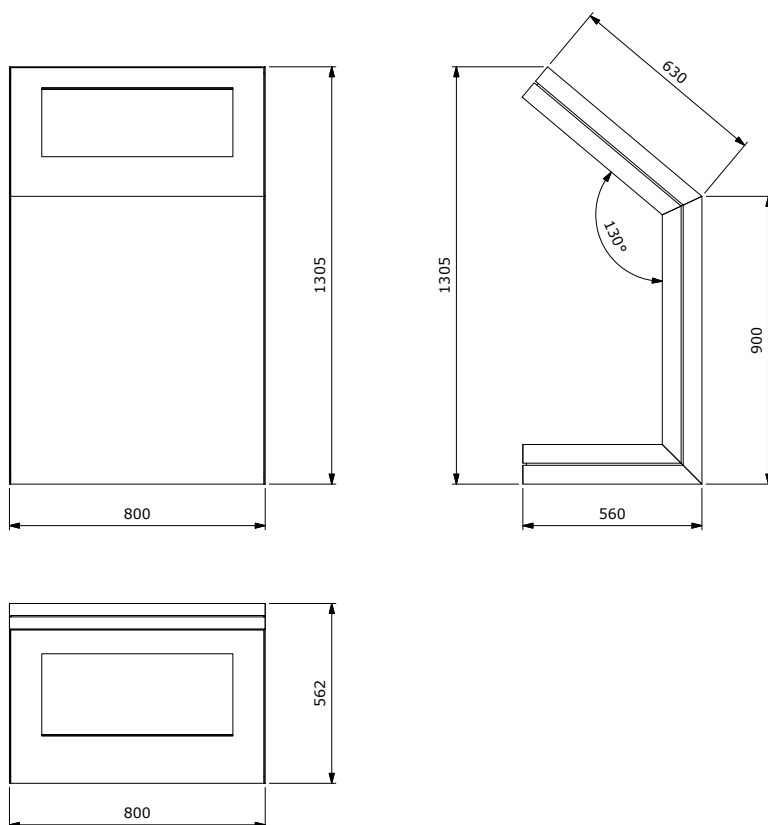

Forester



Colour	Country	Weight	Reference n°
A	EU	38,28 kg	700 0236 0210 A
A	UK	38,28 kg	700 0250 0210 A
B	EU	38,28 kg	700 0236 0210 B
B	UK	38,28 kg	700 0250 0210 B

Height = 2976mm  
 Power: 6 x 35W LED  
 Color temperature: 3000K - CRI90  
 Luminous flux: 6 x 3000lm

Incl. 6 spots 35W

→ Technical information

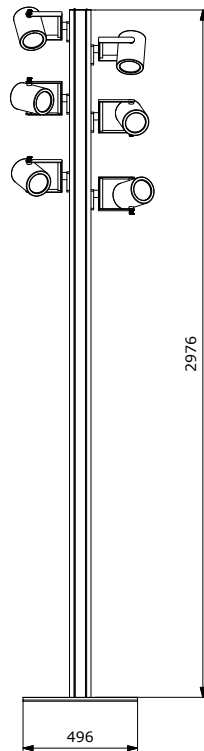

## Lumi-80 lightbox W

Colour	Weight	Reference n°
W	2,8 kg	700 0262 0496 W
W	7,7 kg	700 0262 0992 W
W	10,96 kg	700 0262 1240 W



Aluvibond, fabric infill & wall fixations included. Power cord not included.

### → Technical information

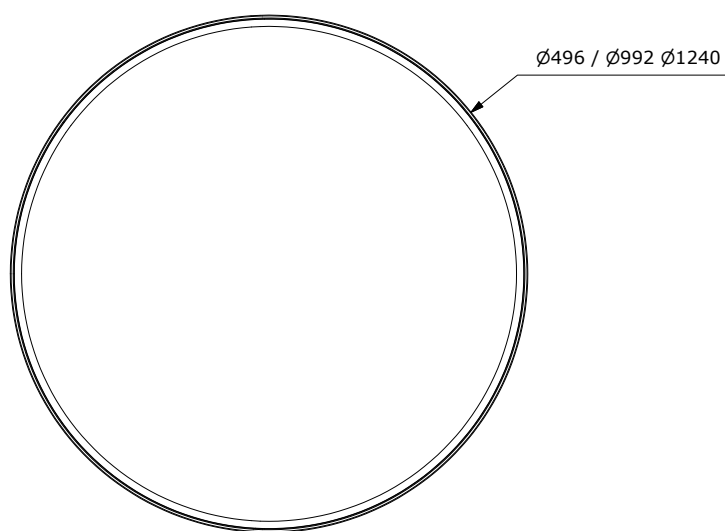



# Look book

Modular desks, mobile eye-catchers and elegant LED solutions





# Contact

## **ALUVISION NV**

Clemence Dosschestraat 44  
9800 Deinze, Belgium  
T: +32 (0)9 381 54 70

[info@aluvision.com](mailto:info@aluvision.com)

## **ALUVISION USA**

1620 Satellite Boulevard, Suite C  
Duluth, GA 30097 USA  
T: +1 (470) 252 3500



STAY IN TOUCH!

**Follow us  
on LinkedIn,  
Instagram,  
Facebook and  
YouTube!**