

We are imagineers



Aluvision



**Our mission
is imagineering.
We inspire &
connect partners
on their creative
journey to design
& build modular
environments.**



Aluvision

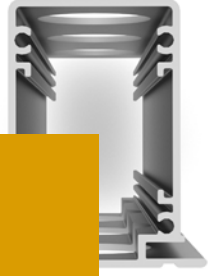

Why choose Aluvision?

- ✓ **Plug-and-play** modular system, toolless assembly
- ✓ **Endless possibilities** using panel, fabric and LED, freedom of configuration and seamless integration
- ✓ **Highest precision standards** in aluminium frame and LED tile production
- ✓ **Engineered to last**, 100% reusable and 100% recyclable
- ✓ **Customer support**, proactive approach
- ✓ **R&D**, the beating heart of Aluvision
- ✓ **Worldwide network**, a focus on long-term partnerships

Decades of experience in making customer projects unique. Let's imagineer.



Make the difference

As innovative developer & worldwide supplier of high quality modular systems for the exhibit and event industry, Aluvision combines bold imagination with unmatched engineering and manufacturing expertise. The Aluvision frame system offers solutions for straight and curved walls, LED videowalls, hanging signs, light walls, displays & retail environments. Durability, reusability, precision, flexibility and modularity are the core features.

Founded in Belgium in 2003, Aluvision currently employs over 120 people and services more than 3 000 partners worldwide. The company has large production facilities and inspiring showrooms in Deinze (BE) and Atlanta (USA), as well as a warehouse in Sydney (AUS).

Your partner
in **modular** stand
solutions



EFFICIENCY

We continuously strive for maximal output with minimal effort. Our frame systems are easy to build (no tools needed!) and guarantee a high return on investment.



INNOVATION

With research and development at the core of our company, we aim to build intelligent products with a lean design, while continuously looking for new technologies.



QUALITY

From production to customer service – we always strive for high-end quality. A keen eye for detail and internal quality checks ensure we deliver on our promises.



MODULARITY

Our modular design offers endless combinations and creative possibilities with a wide range of materials and reusable products.



SUSTAINABILITY

We limit our environmental impact by producing reusable and recyclable light-weight products with a long lifespan. Moreover, our production plant mainly runs on solar energy and we sustain our own waste-management programme.

We are imagineers





Keep it simple

Smart design is driven by simplicity. The strength of our toolless frame system lays in its intuitive and fast installation. Plug & play!

Be a trendsetter

In the fast-moving world of trade shows and exhibitions, new product design is the key to continuous growth. Being the leading system supplier in the event industry, Aluvision always stays one step ahead.

Invest in the future

In order to ensure company growth, continuous investments are required. Aluvision focuses on the future by using the latest production technologies and by stimulating talent and team spirit.

Think global

In the exhibition industry, globalisation is evident. Aluvision shares this spirit by having a worldwide support and distribution network, with production facilities both in Europe and the USA.

Get inspired

The concept gallery is the fastest way to find some ready-made booth designs. Discover our concept gallery online! The filter function will help you select the type of booth you're looking for. It will also show you the numerous possibilities Aluvison has to offer. However, do not let this gallery restrict your ideas. Tease your imagination and you will be amazed.

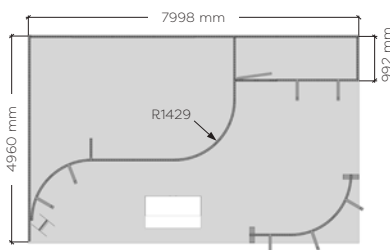
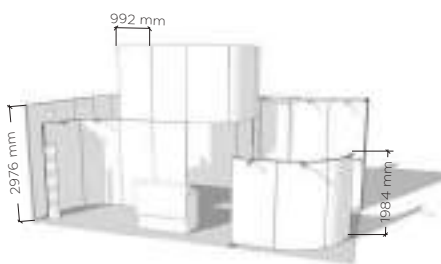
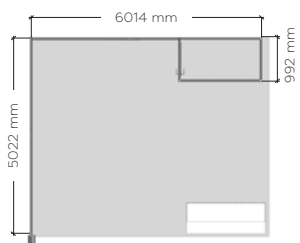
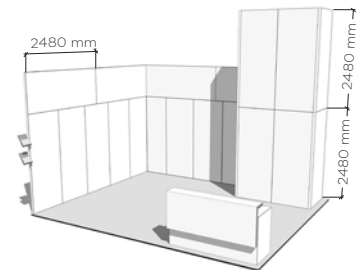
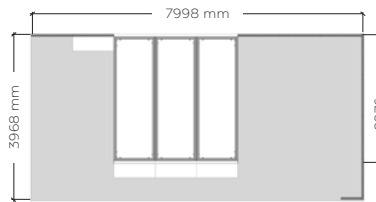
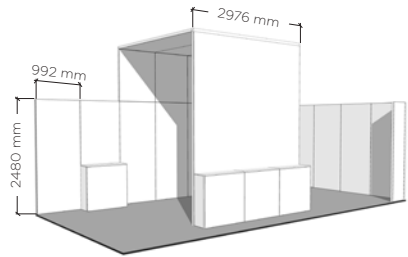
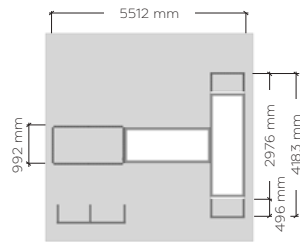
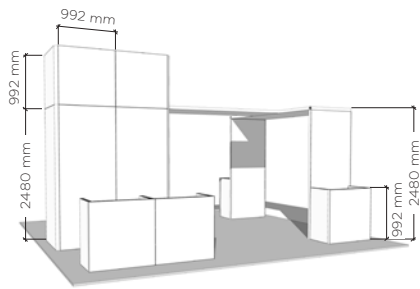

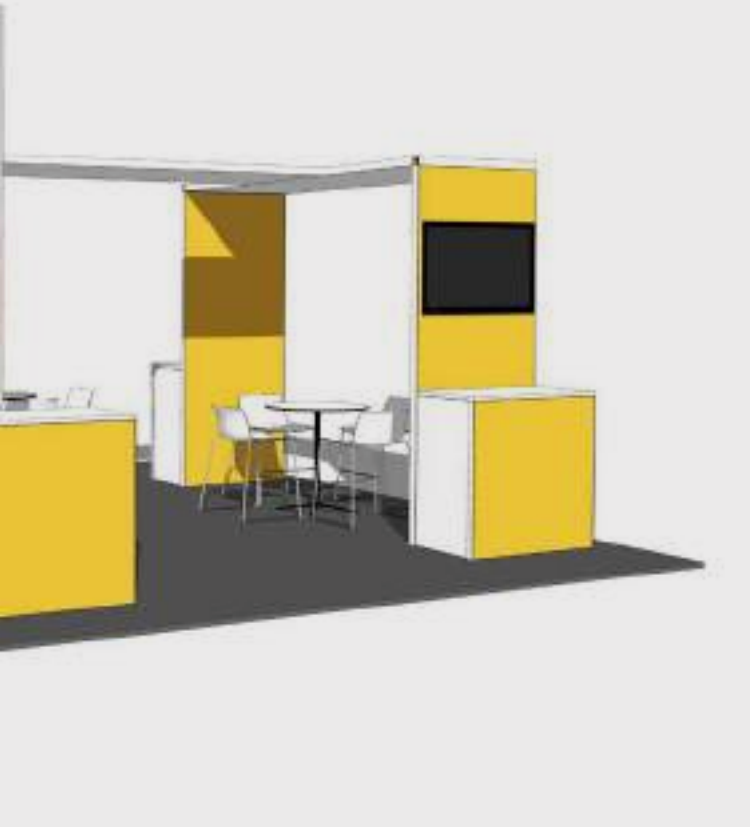

START EXPLORING

Set yourself up for success with one of our multifunctional starter kits

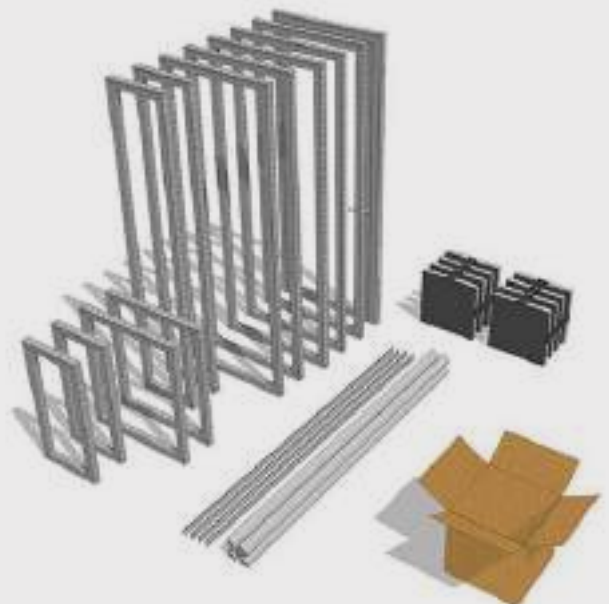

This simple purchase will lead to an optimal return on investment (ROI). A perfect start for a long-term collaboration. Combinations are endless: you can keep re-using and re-configuring the same frames or further expand by adding new frames and parts. Discover them online!

www.aluvision.com

Combine panel and fabric in one system

The best of both worlds. Continue building with standard, easy to handle frame sizes, and have one large SEG (Silicone Edge Graphic) seamlessly run over several frames. If needed, a rigid panel can be placed behind the fabric (e.g. for doors) or the use of fabrics and panels can be alternated. The most efficient concept in terms of reusability and flexibility of wall and ceiling frames.



Hybrid frames (Omni)

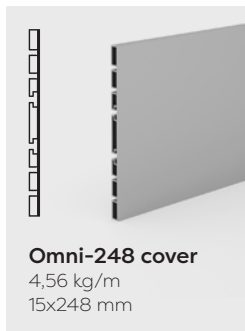
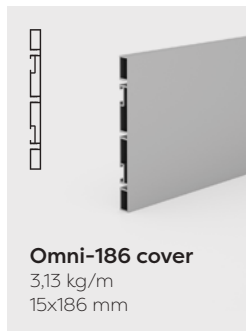
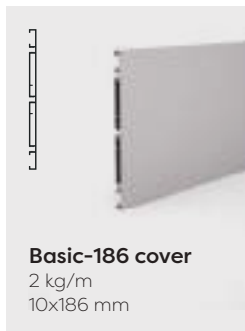
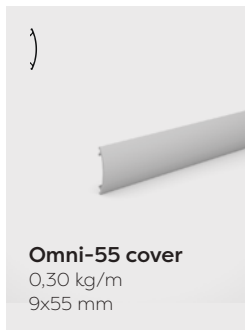
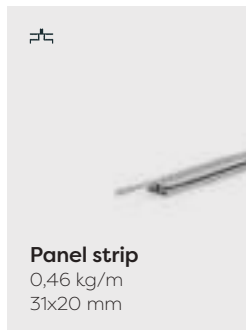
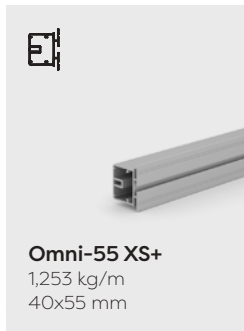

Solid integration of glass walls and doors

The Basic-55 glass profile is the most elegant solution for the integration of glass or acrylic walls and doors into your design. The frames ensure a seamless application of glass infills with a narrow edge to stay visually appealing. These frames are compatible with all 55 mm frame systems.

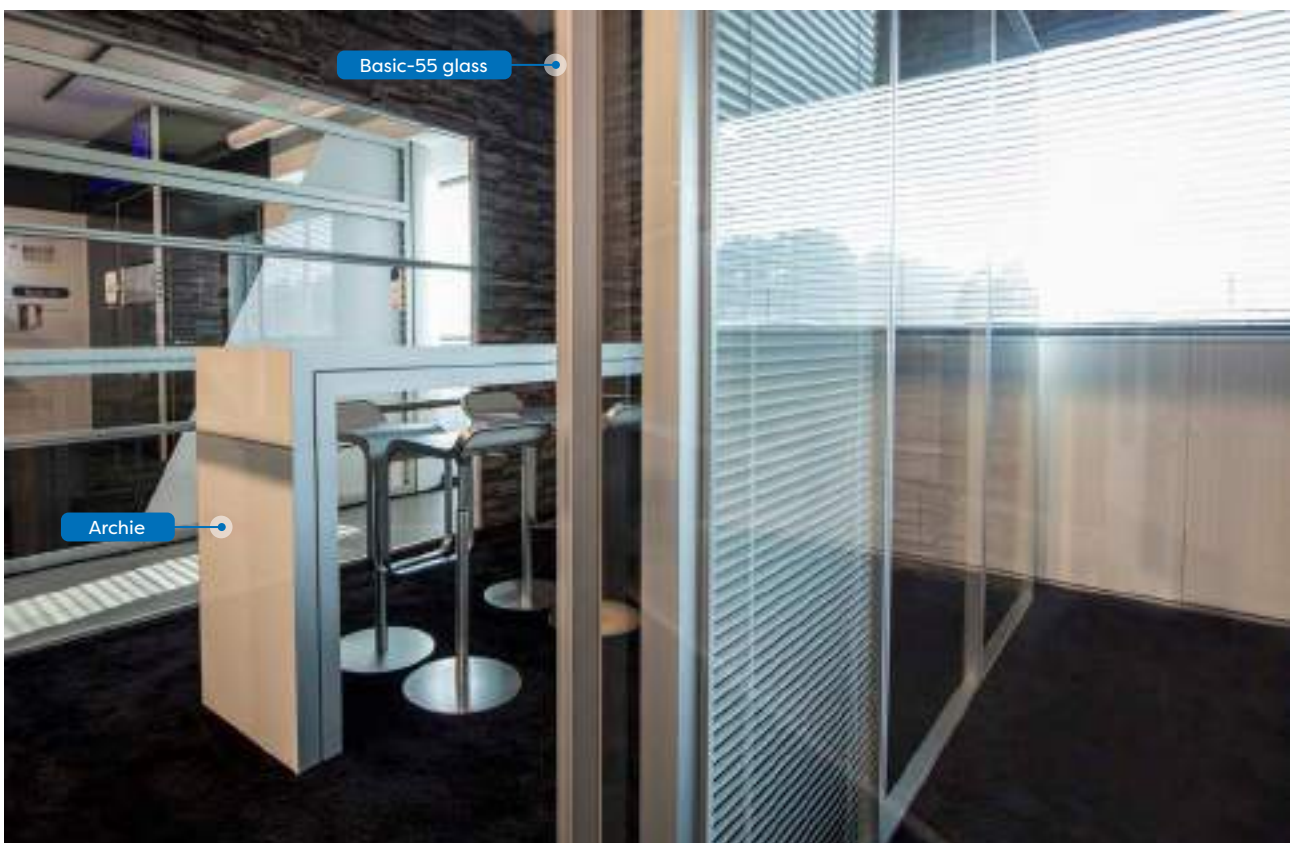

Glass solution (Basic)

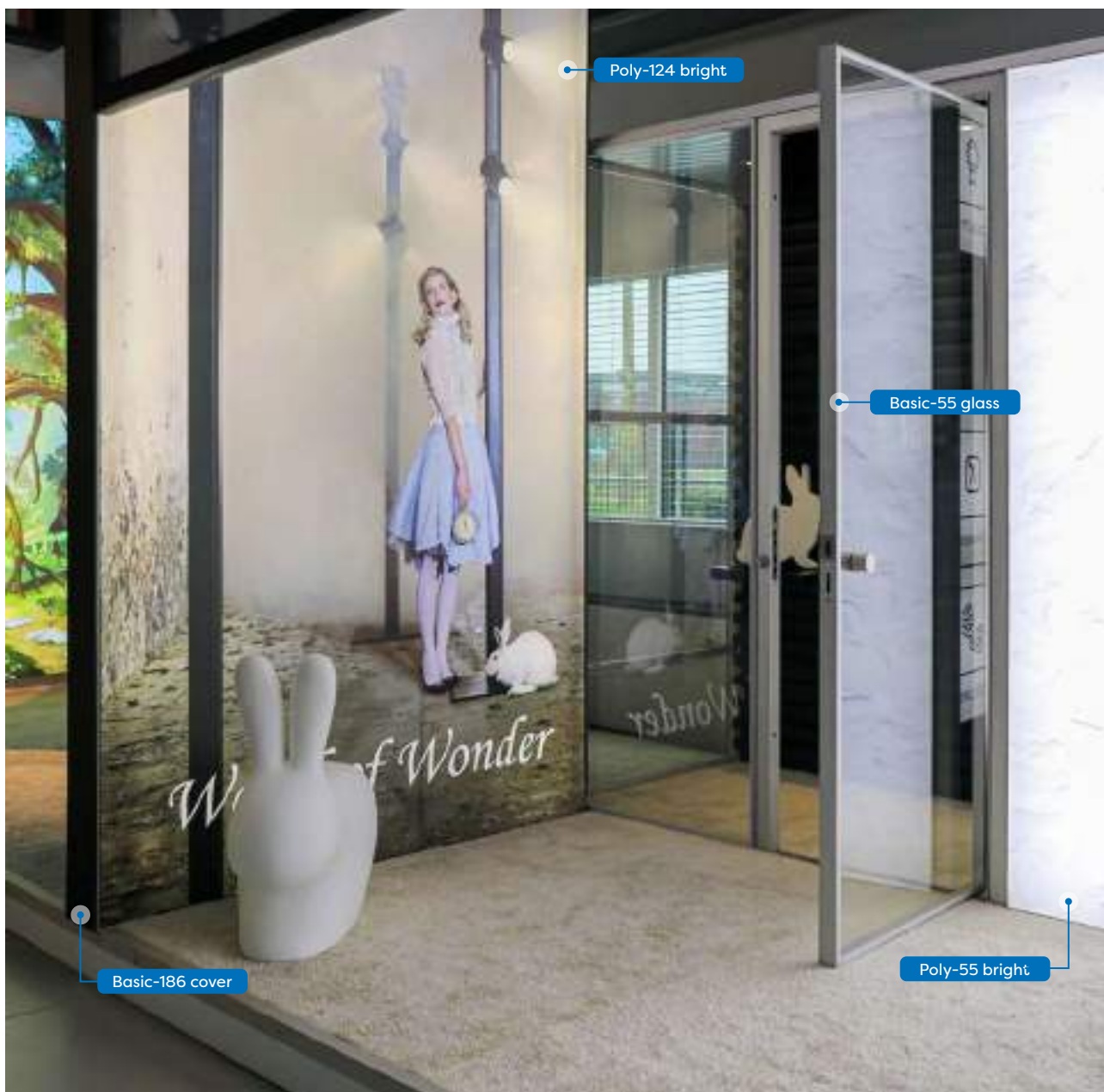

Seamless fabric walls for large graphics

This range of solutions is used for straight walls and in specific cases also for curved walls. The frames can be rectangular or have curved corners allowing for maximum design possibilities. Profiles are available in different depths to allow for an optimal solution in every situation. Most of the systems take the standard 15 mm silicon edge, but in some case a 7 mm silicon edge is used. Frames can be easily disassembled allowing you to reduce transport volume. Aluvision will be happy to advise you on which system to use in which situation.



Fabric frames (Fab)

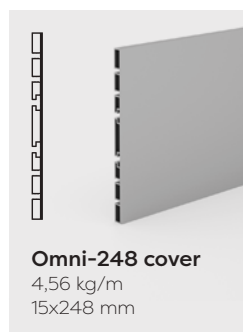
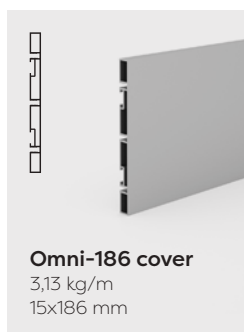

LED light wall solutions

Illuminate your large format graphics and boost your commercial message. By using the LED edge lighting technology, the packaging volume has been reduced to a minimum. Installation takes nothing more than assembling four aluminium profiles into a lightweight, yet rigid frame and attaching a SEG (Silicone Edge Graphic), without requiring any tools. The high quality LEDs ensure an intense and uniform illumination for light walls up to 5 m wide.



Light walls

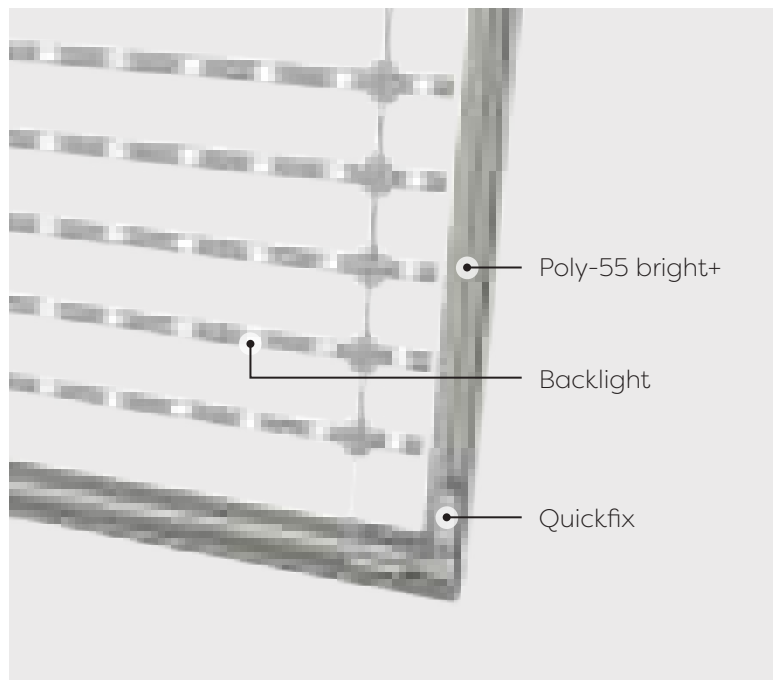
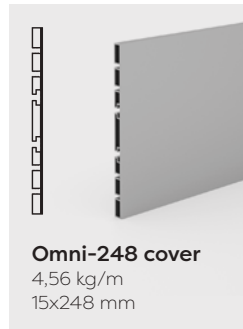
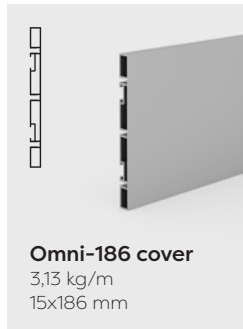
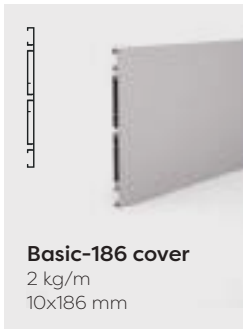
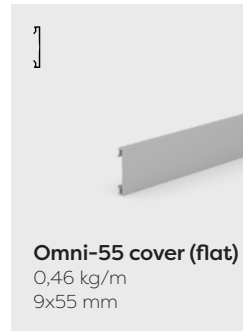
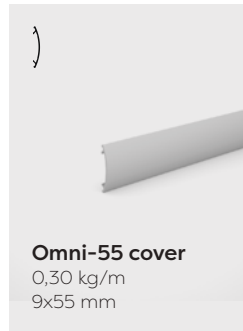
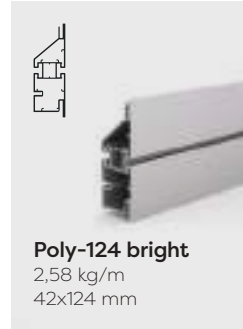

Finishing options

“The details are not the details. They make the design.” That is why Aluvision has developed a wide range of finishing options and accessories to give you everything you need to create a product with a high quality finish, even to the smallest detail.



Corner profiles

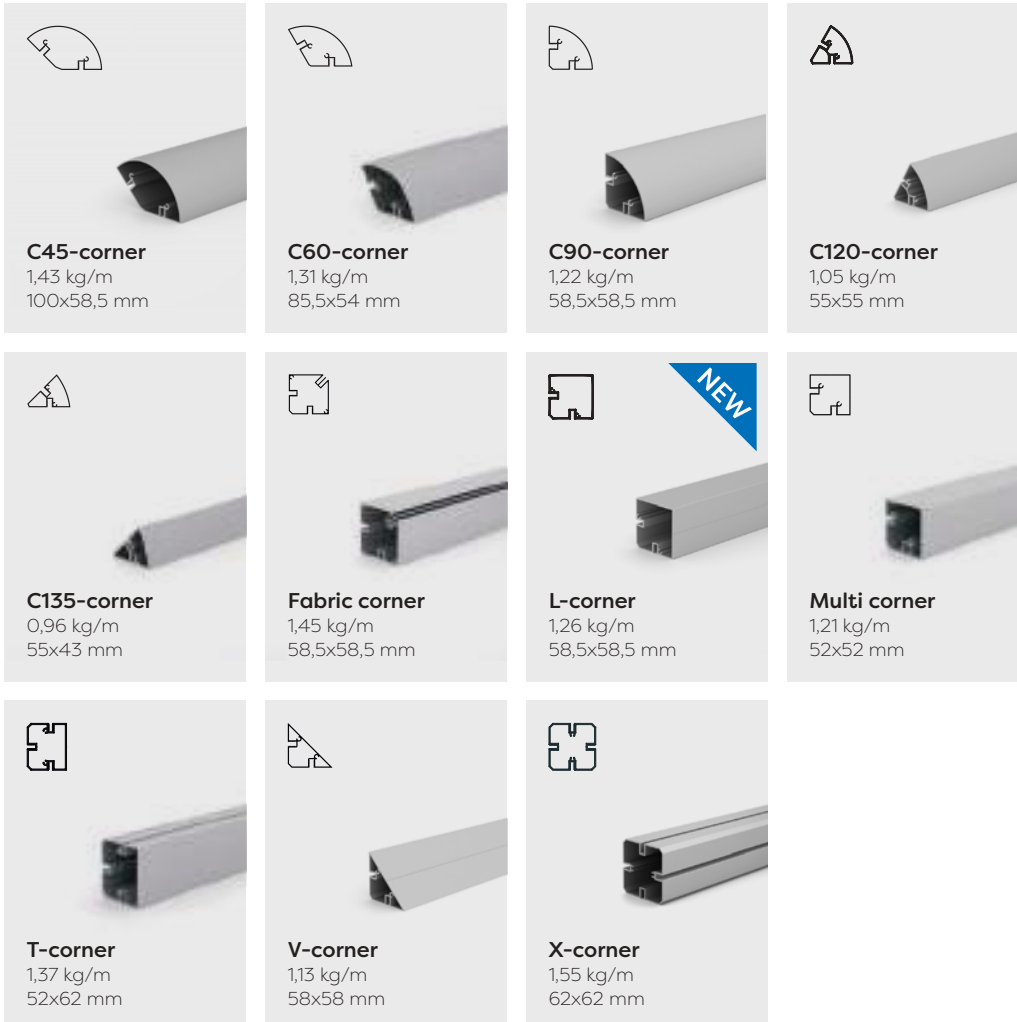

Hanging signs

Hanging signs attract the attention from far away. It is all about standing out from the crowd! Aluvision has a range of solutions with or without backlighting and using rigid or fabric infills. All systems are very user friendly and easy to build. You can use the quickfix corner connectors or the very handy 3D corner pieces with a slide & fix system. We will be happy to advise what system to choose in your specific situation.





3D structures with tension fabric or panel



Sub box
0,96 kg/m
64x47 mm
for fabric





Ino box
1,24 kg/m
69x43 mm
for fabric

Super box
1,94 kg/m
93,62 mm
for fabric



B-box
1,1 kg/m
46,5x46,5 mm
for panel

E-box
0,29 kg/m
22x12,5 mm
for fabric



Structures

A range of highly aesthetical structural profiles is available to be used as stand alone solutions or in combination with other systems. All systems have been developed to be assembled using a minimum of tools & time and blend in perfectly with the other systems for fabric or panels. Let us advise you on how to use this very functional range of profiles and connections.



Structural profiles



Lighting objects

Putting something “in the spotlight” has never been easier than with our lighting fixtures. Discover our award winning Puck Flex, our brand new Puck XL, Forester and Lumi-80. Those looking for a more traditional stem light will find an answer in our LED Display Spot.



reddot award 2014
winner



The Puck XL

Ref. n°
700 0265 0050 L

Colors
Cold white
Warm white

Extras

- Daisy chain
- 50 W
- Choose between warm white or cold white at the push of a button
- Special lens for an even, wide light distribution

Elegant LED solutions

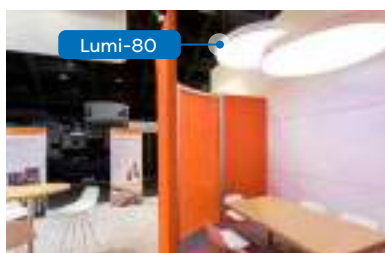

Readymades and displays

Whether you are looking for a modular desk to integrate in your booth or you simply like the sleek look of our aluminium profiles and want to use them in your office environment, Aluvision's frames and profiles are the perfect solution for modular desks and tables. Discover the possibilities of using fabric walls, lightboxes or regular frames as stand alone displays.

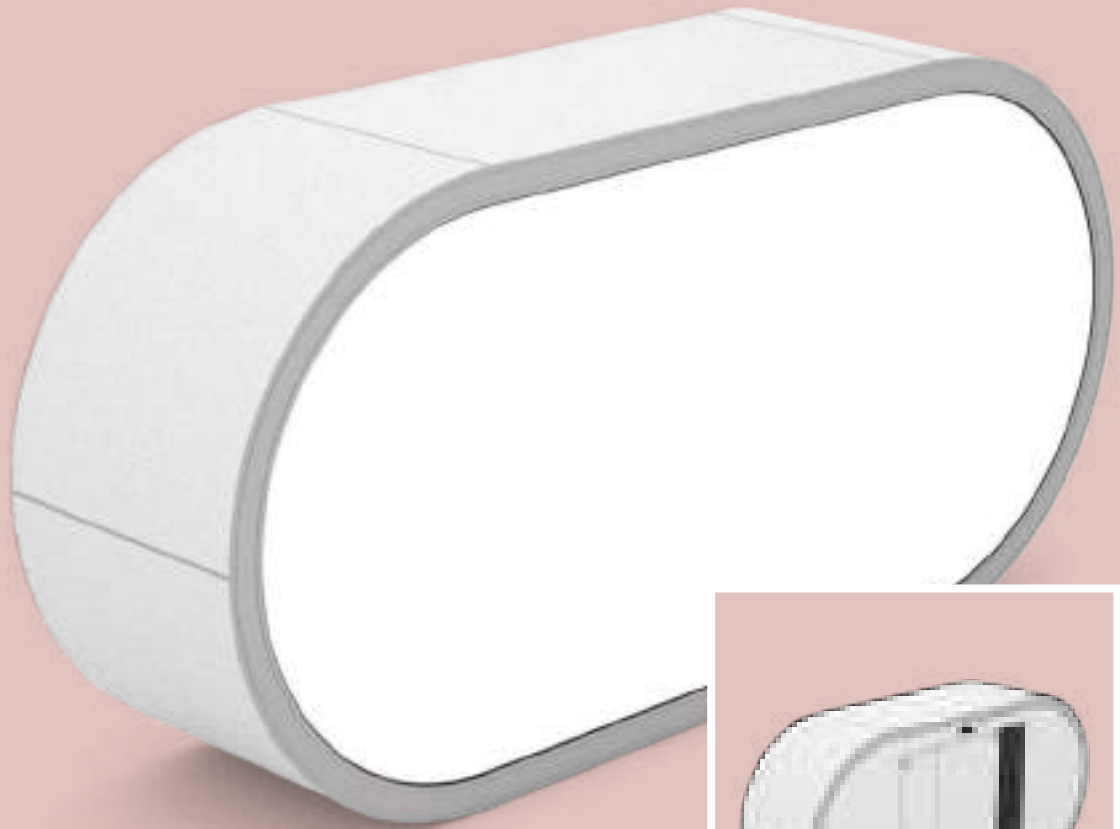

N-counter series

Ref. n°
87 0601

Colors
● ●

Extras
Option backlit
Option sliding/pivot door

Modular desks and mobile eye-catchers

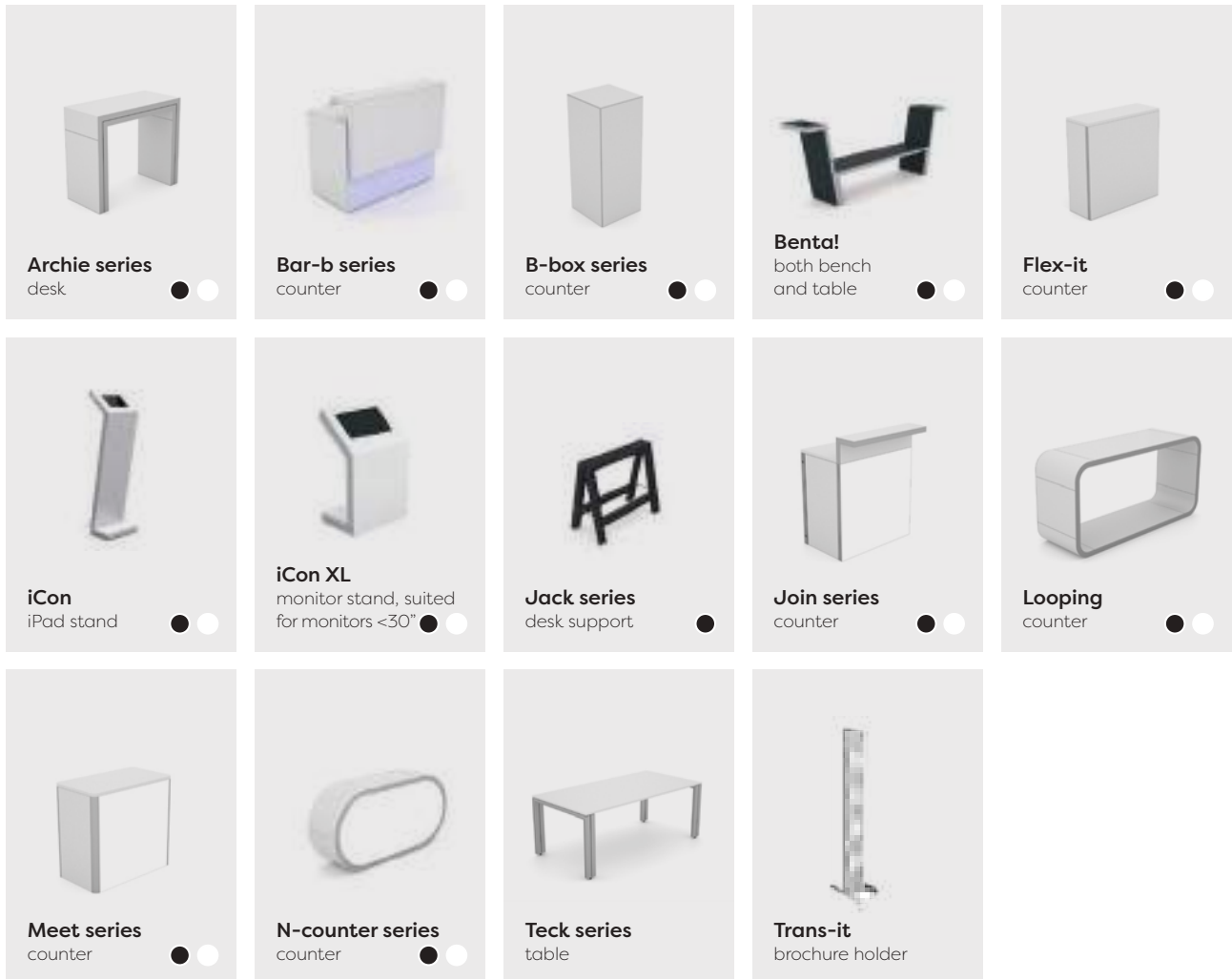

⊕ You can find more information in our **Readymades brochure**.

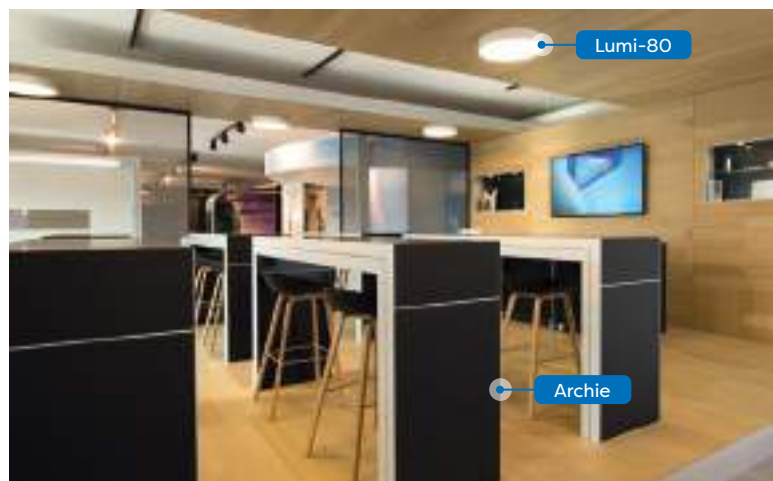

We take you to a higher level

The Step floor is easy to install and adjustable in height. The system combines pre-mounted frames with corner and edge modules. The standard grid is 1 by 1 meter but thanks to a supporting surface to either side of the T-shaped Step profile, you only need half of the amount of floor frames that you would expect.

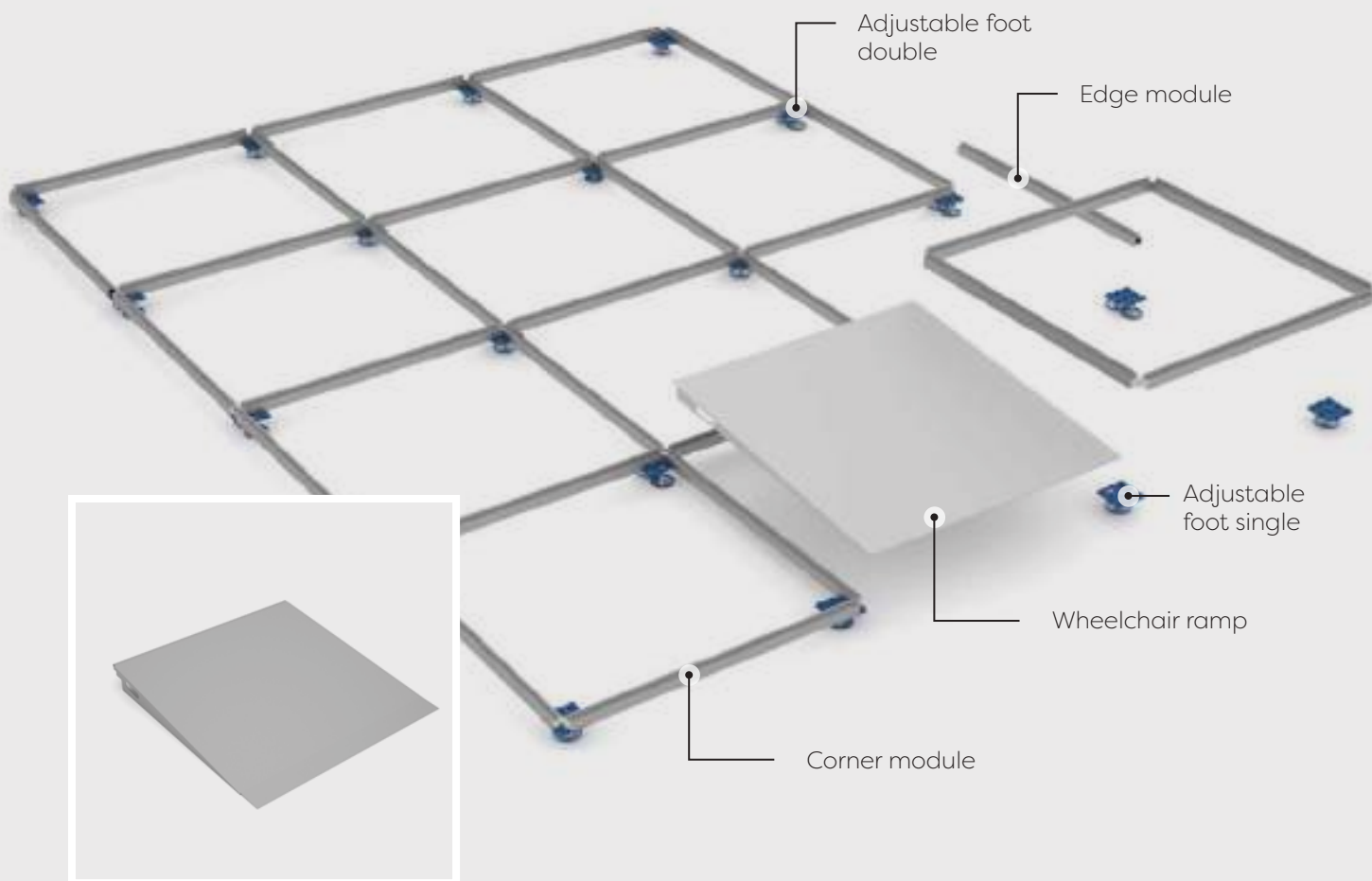

Step wheelchair ramp

Ref. n°
65 21 3801 L

Technical and fast-building raised floor

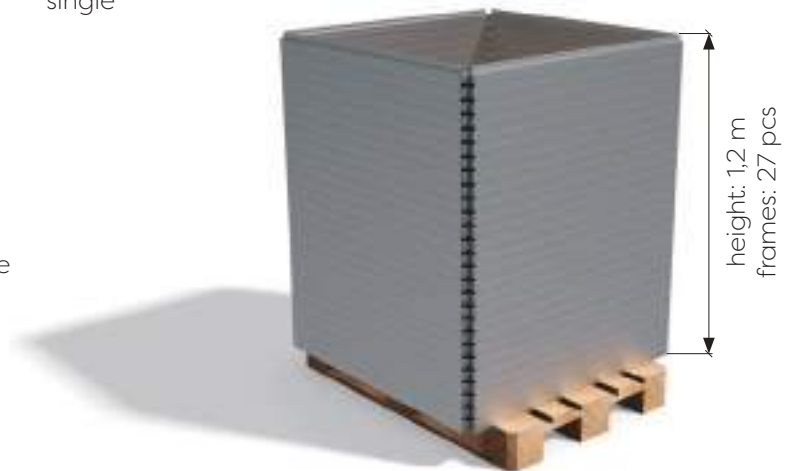
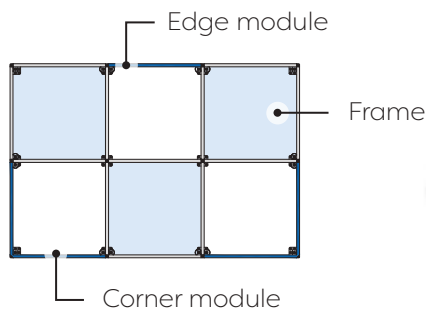
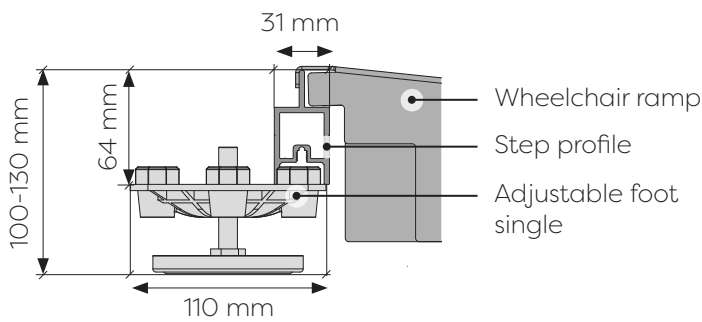
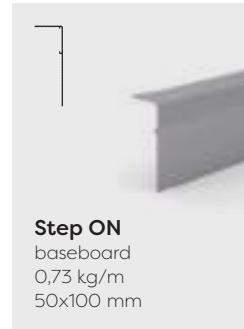

Create a powerful visual experience

The Hi-LED 55 is the thinnest LED tile available that can be seamlessly incorporated into a modular construction system. Its unique dimensions of 496x496x55 mm ensure compatibility with the original Aluvision frame system. The 2.8 and 2.5 pixel pitch and premium level flatness guarantee a brilliant visual experience and a supreme image quality.

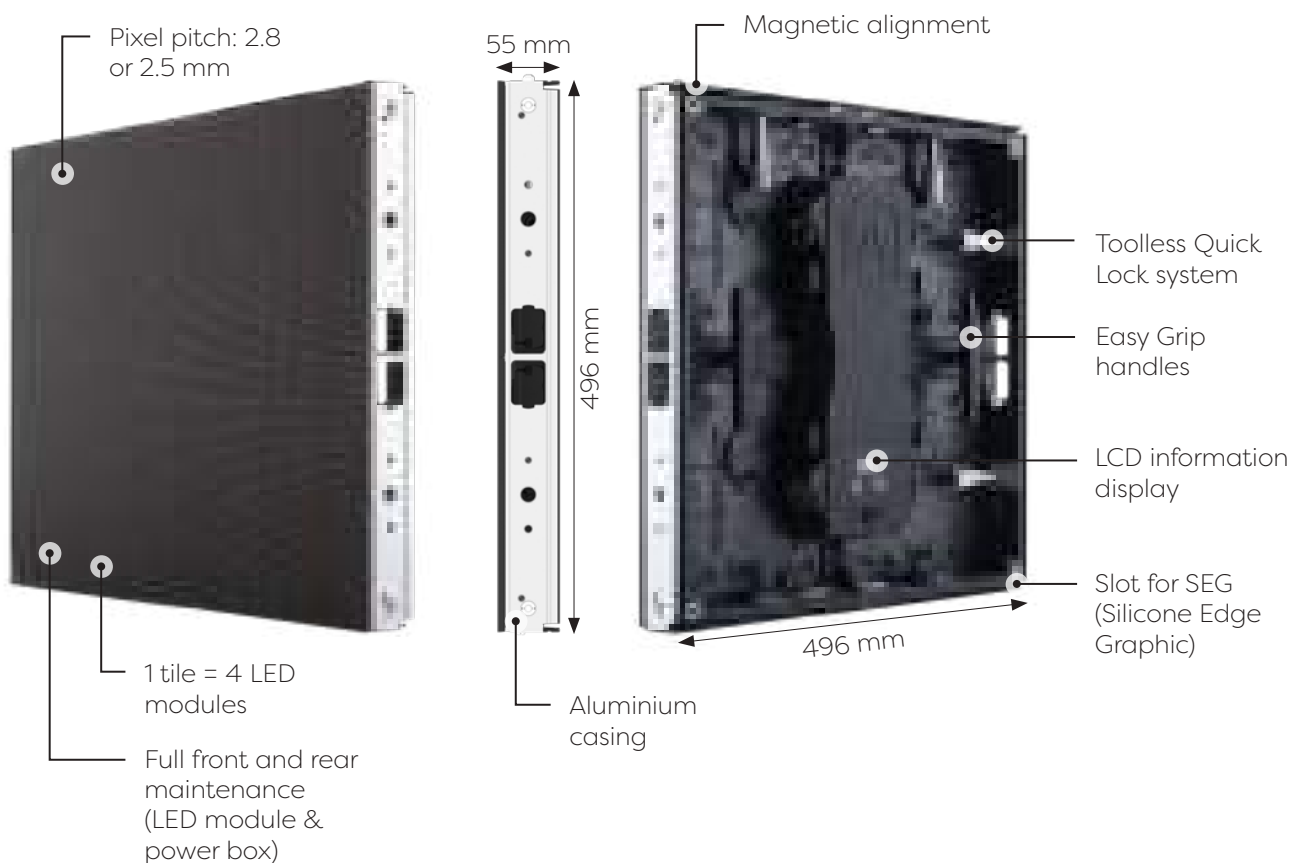

⊕ You can find more information in our **Hi-LED 55 brochure**.

Flush integration with the original Aluvision frame system

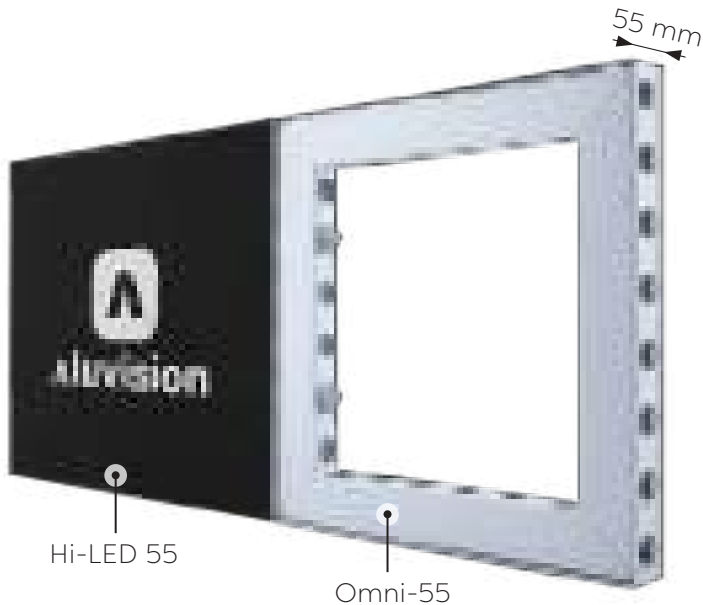

Why choose Hi-LED 55?

- ✓ Straight & curved LED tiles for walls, ceilings and floors
- ✓ Advanced all-in-one design
- ✓ Quick, easy and toolless installation
- ✓ Full front & rear maintenance (both LED modules and power box)
- ✓ Raised flooring system
- ✓ One tile, endless solutions: Hi-LED 55+
- ✓ Endless possibilities for assembly, including concave & convex mounting
- ✓ Specially developed flight cases for secure transportation

Seamless modular LED video walls

Boost your tradeshow presence by integrating in the Hi-LED 55 range into any setup you can think of. Choose wall, display, ceiling, floor or hanging constructions to bring your creative ideas to life. Be ahead of the curve with our new Hi-LED 55 convex and concave tiles. Available in three radii, these curved tiles can give your design a new twist.



Next-generation LED tiles for seamless integration

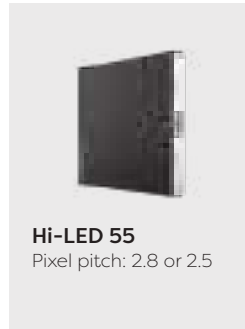

Hi-LED 55
Pixel pitch: 2.8 or 2.5

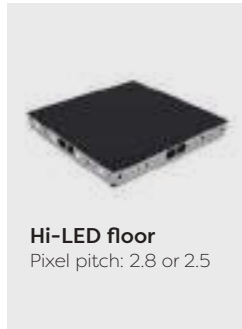

Hi-LED floor
Pixel pitch: 2.8 or 2.5

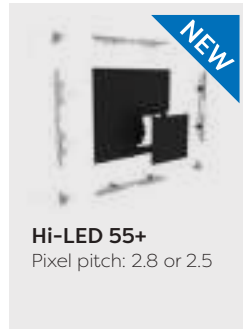

Hi-LED 55+
Pixel pitch: 2.8 or 2.5



Hi-LED R437 convex
Pixel pitch: 2.8 or 2.5
¼ circle segment



Hi-LED R437 concave
Pixel pitch: 2.8 or 2.5
¼ circle segment



Hi-LED R1476 concave
Pixel pitch: 2.8 or 2.5
½ circle segment

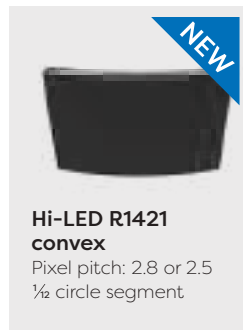

Hi-LED R1421 convex
Pixel pitch: 2.8 or 2.5
½ circle segment



Dynamic LED 55
Pixel pitch: 20
use in combination with fabric

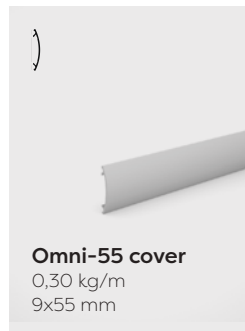

Omni-55 cover
0,30 kg/m
9x55 mm



Omni-55 cover (flat)
0,46 kg/m
9x55 mm

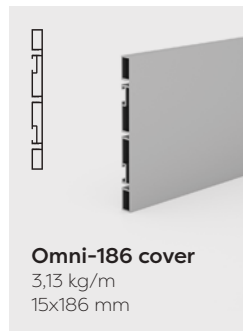

Omni-186 cover
3,13 kg/m
15x186 mm

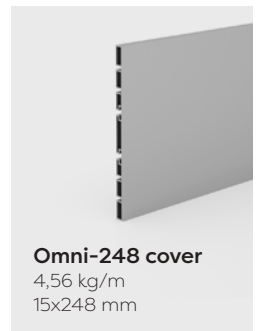

Omni-248 cover
4,56 kg/m
15x248 mm



Omni-55 ledline
0,624 kg/m
31x55 mm



One tile, endless solutions



Hi-LED 55+

- Pitch 2.8 or 2.5 mm
- All modules have 4 chamfered sides
- Modules are compatible with Hi-LED 55
- Patented

Transform the most versatile LED tile into 5 different configurations

1

Straight tile

This is where it all begins. A convertible LED tile, fully compatible with the Aluvision frame system and Hi-LED 55.



2

Corner

Let's get the magic started & convert two tiles into a seamless 90° corner.

3

3D corner

Let's add a little extra, and create a 3D corner. Don't forget, all of this with just one building block.



4

Cube

Let's go all the way and create a cube. This tile is able to seamlessly finish up to 6 sides. Combine more Hi-LED 55 tiles to create different sizes.

5

Concave & convex

Let's create an edge. Think waves, curved walls, or basically any curved construction. Just go wild!



The world is at your feet

From a dynamic floor at exhibitions, to an eye-catcher at your corporate event, anything is possible with this raised LED flooring system. This floor is built out of a solid aluminium subflooring and hardened glass to protect the LED units. Thanks to the adjustable foot, you can level the floor between 120 and 145 mm.

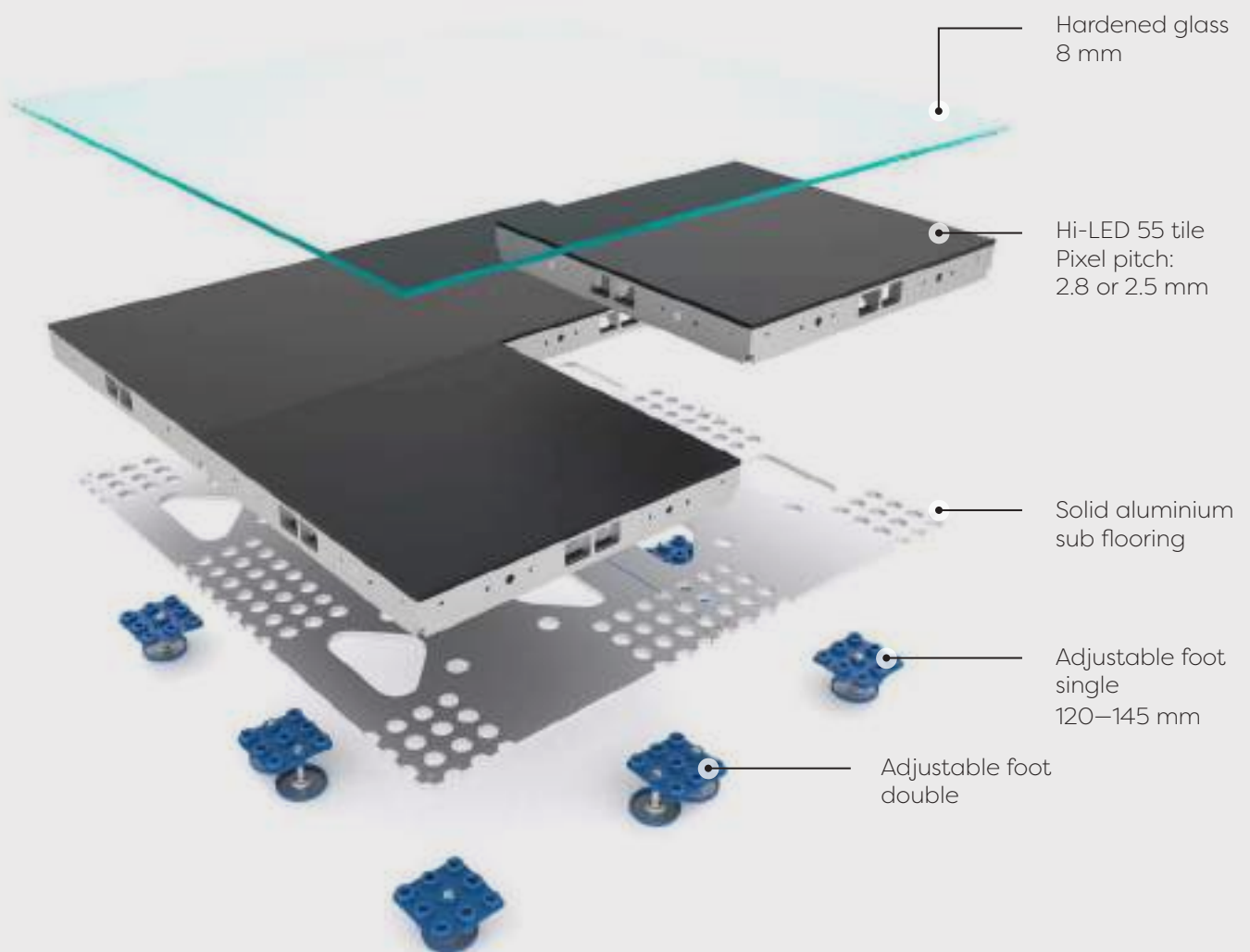

Hi-LED 55 raised flooring system

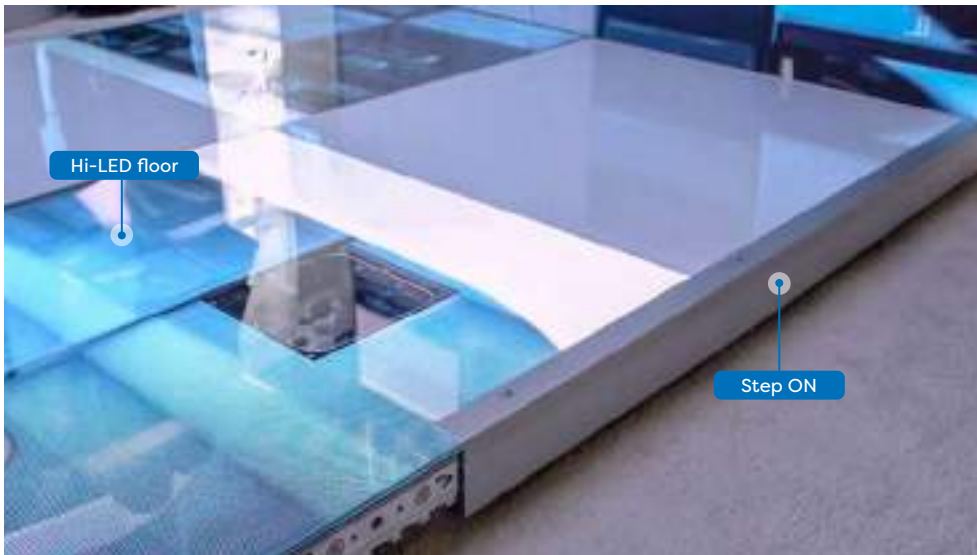
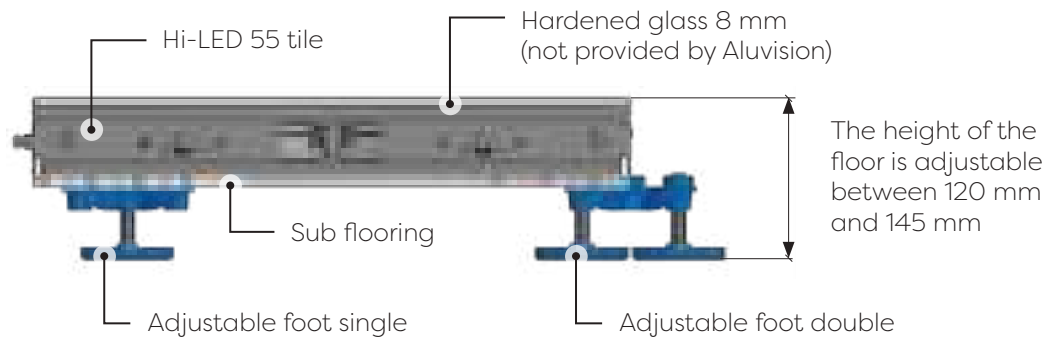

QuiXy, the smart exhibition kit

So you need a fair booth that spells wow, but with a budget that doesn't? QuiXy is a modular stand building kit that lets you combine walls, displays, desks and more in a heartbeat. It's easy to stand out.

Make your pick out of 20 different plug & play units to build a fully-fledged fair booth that boasts Aluvision quality.



⊕ You can find more information in our **QuiXy brochure**.

01

Choose & combine

Pick any standard QuiXy building unit and create your unique QuiXy design.

02

Deliver & delight

Astound with fast delivery and installation. A perfect booth, a satisfied customer.

03

Amaze & succeed

Blow away your customer, present a stunning design in no time and generate a sure-sell.

EASY AS
TOASTING BREAD

Booths just got better... minimum effort, for maximum impact!

- ✓ Plug & play booth, no tools needed
- ✓ Prime quality at a sharp price
- ✓ Delivery in a compact flightcase
- ✓ Modular set-up; easy to reuse
- ✓ 1 kit = a wide variety of set-ups



Setting up your booth should be easy, so we simply made it easy

QuiXy, the perfect match between quality, easy set-up and price. Stand out combining walls, arches, storage spaces, desks or even a monitor. It's easy as 1-2-3!



Your QuiXy in a handy flightcase or trolley

Size flightcase: 2500x710x1600 mm
Size trolley: 2570x790x1500 mm



Play around with 20 standard units to create different designs



Storage unit
558x1116x2480 mm
Ref. Q01 04 0002 A



Storage unit
558x558x2480 mm
Ref. Q01 04 0001 A



Storage unit
992x1116x2480 mm
Ref. Q01 04 0003 A



Arch unit
992x2356x2480 mm
Ref. Q01 03 0001 A



Lightbox arch unit
992x2356x2480 mm
Ref. Q01 03 0002 A



Arch + monitor unit
992x2356x2480 mm
Ref. Q01 03 0003 A



Lightbox arch + monitor unit
992x2356x2480 mm
Ref. Q01 03 0004 A



Wall unit
434x2480 mm
Ref. Q01 06 0001 A



Wall unit
992x2480 mm
Ref. Q01 06 0002 A



Lightwall unit
992x2480 mm
Ref. Q01 06 0003 A



X-corner profile
2480 mm
Ref. Q03 49 0001 A



Shelf unit
992x2480 mm
Ref. Q01 01 0001 A



Monitor + counter unit
992x992x2480 mm
Ref. Q01 02 0001 A



Monitor + shelf unit
992x2480 mm
Ref. Q01 02 0002 A



Counter unit (with door)
620x496x992 mm
Ref. Q01 05 0001 A



Counter unit (with door)
992x496x992 mm
Ref. Q01 05 0003 A



Counter unit (without door)
620x496x992 mm
Ref. Q01 05 0002 A



Counter unit (without door)
992x496x992 mm
Ref. Q01 05 0004 A



Counter add-on unit
992x496x992 mm
Ref. Q01 05 0005 A



Lightbox header
992x496 mm
Ref. Q01 07 0002 A

Work smarter, use our Genius tools

Genius configurator

The perfect sales tool for a quick and easy 3D rendered stand design. This intuitive configurator uses drag & drop to get you started in no time. Add striking visuals to your frames and moving content to your Hi-LED 55 tiles to create the perfect representation of what your design will look like in real life. Connectors are added automatically and pricing & parts lists are generated instantly. All just a click away, free of charge!

Genius showplanner

Stay ahead of your projects and keep a full inventory overview. Create a complete material stock list, plan your tradeshow, and link products to specific jobs. The Genius showplanner will do the rest: inform you about availabilities and deadlines, create reports, etc. The ideal preparation tool for every project!

Aluvision app

Get your technical product information first hand: guaranteed to be up-to-date at all times. Just register on our website and you're all set to download and access this useful, free app from the App Store or Google Play.





4 tools, many advantages

- ✓ Designing your booth just got easier
- ✓ Plan ahead
- ✓ Intuitive
- ✓ Always keep track of your budget and inventory
- ✓ Make a sure-sell!

What are you waiting for?
Go wild, try it!

Genius for SketchUp

Designing in 3D is now easier than ever! The “Genius for SketchUp” plugin is a practical extension for the user-friendly SketchUp design program that allows you to quickly import the entire Aluvision range from the 3D Warehouse. All parts are only a click away! Use the concept gallery with various designs to get inspired or start from scratch; it’s up to you. With the click of a button, get an instant quote and parts list. Frequently updated with new design features, this is the perfect solution to quickly create advanced designs and personalised quotes that will impress your clients. Will you go the extra mile?

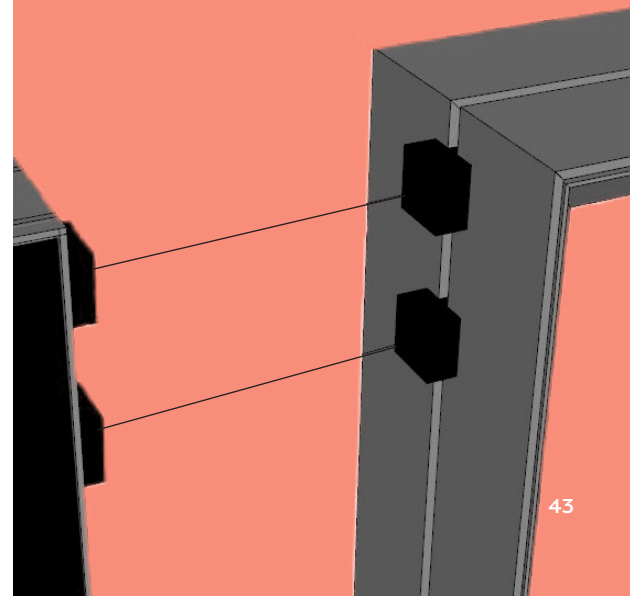

Contact

ALUVISION NV

Clemence Dosschestraat 44
9800 Deinze, Belgium
T: +32 (0)9 381 54 70

info@aluvision.com

ALUVISION USA

1620 Satellite Boulevard, Suite C
Duluth, GA 30097 USA
T: +1 (470) 252 3500



STAY IN TOUCH!

**Follow us
on LinkedIn,
Instagram,
Facebook
& YouTube!**